



Instructions and warnings for installation and use

This Motor uses Merlin late model MS105MYQ Rails

**To set limits set menu 1, 2 and 3 then at end of 3 push and hold the P button to exit immediately after door closes
READ ALL NOTES to get it correct.**

Forza is a Boss Motor using its only unique remotes frequency that is Clone-able with smooth remotes and then needs to be programmed into the motor like a ATA PTX4

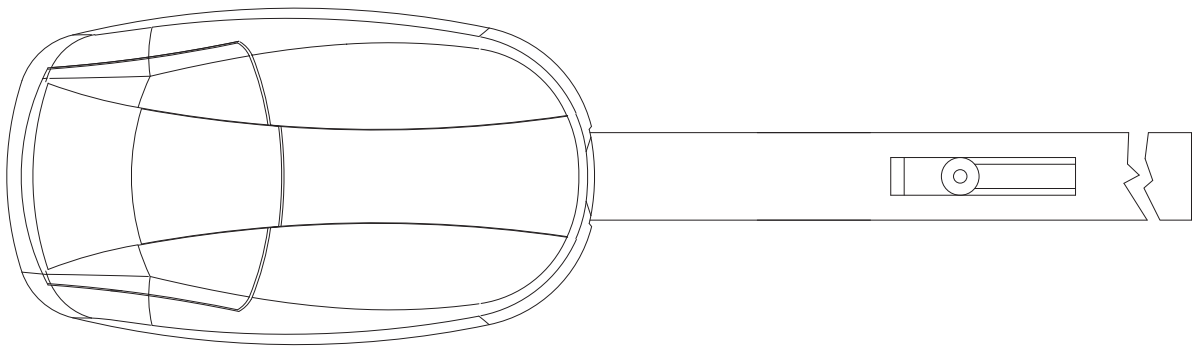

FORZA

SECTIONAL GARAGE DOOR OPENER



INDEX

1	Safety Warnings	p. 3
2	Product Overview	p. 4
	2.1 Description of the Product	p. 4
	2.2 Parts List	p. 4
	2.3 Specifications	p. 5
	2.4 List of Cables Needed	p. 6
3	Preliminary Checks	p. 6
4	Installing the Opener	p. 6
	4.1 Assembly of Guide Rail in 3 Parts	p. 6
	4.2 Connection of the Motor Body to the Guide Rail	p. 7
	4.3 Installation of the Guide Rail and Motor on the door	p. 7
	4.4 Manual Opening of Door	p. 7
	4.5 Wiring Diagram	p. 8
	4.6 Normal Mode LCD Display	p. 8
	4.7 Programming	p. 8
	4.7.1 Setting of Opening Limit	p. 8
	4.7.2 Setting of Closing Limit	p. 9
	4.7.3 Force Learning Activation	p. 9
	4.7.4 Setting Force Level	p. 9
	4.7.5 Remote Transmitter	p. 10
	4.7.6 Photocell Function Setting	p. 10
	4.7.7 Setting of the Duration of Automatic Closure	p. 10
	4.7.8 Setting of Alarm for 2000 Operating Cycles	p. 10
	4.7.9 Opening Command Setting	p. 11
	4.7.10 End of Programming	p. 11
	4.8 Saving & Deleting Remote Transmitters	p. 11
	4.9 Troubleshooting	p. 12
5	Final Testing of the Opener	p. 12
6	Battery Backup Connection	p. 13
7	Instructions and Warnings for the end user	p. 13
8	EC Declaration of Conformity	p. 15

1 - SAFETY WARNINGS

WARNING - for the safety of personnel, it is important to follow these instructions and save them for future use.

Read the instructions carefully before you start the installation.

The design and manufacture of the devices making up the product and the information contained in this manual comply with safety regulations. However, wrong installation and programming may cause serious physical injury to those who perform the work and those who will use the device. For this reason, during installation, it is important to carefully follow all instructions in this manual.

Do not proceed with the installation if you have any doubts.

In view of this, the final connections to the power supply of the opener, the system tests, its commissioning and maintenance must be performed by qualified and experienced personnel, according to the instructions in "Final Testing of the Opener".

IMPORTANT - Before starting the installation, perform the following analysis and tests:

Ensure that the individual opener is suitable for the installation to be made. In this regard, check with particular attention the data contained in the "Specifications" section. Do not install if the opener is not suitable for use.

Considering the hazards that may occur during installation and use of the product you need to install the opener observing the following precautions:

Do not make changes to any part of the opener, other than those specified in this manual. Any changes made that are not specified in this manual may lead to a malfunction. The manufacturer disclaims any liability for damage arising from products that are not compliant with this manual.

Keep all parts away from water or other liquids. During the installation, ensure that no liquid can penetrate into the opener.

If liquid spills into any part of the opener components, immediately disconnect the power supply and contact your opener supplier. The use of the opener under these conditions can be dangerous.

Do not place the various components near sources of heat and do not expose them to open flame. These actions may damage them and cause malfunctions, fire or danger.

All operations requiring the opening of the protective cover opener, must be performed with the control unit disconnected from the main supply.

The control unit must be connected to a power supply line provided with earth connection;

The product cannot be considered an effective system of protection against intrusion. If security is of concern, you need to integrate the opener with other devices;

The product can be used only after the commissioning of opener has been made, as provided in Section 5 - "Final Testing of the Opener" ;

For the connection of pipes and conduit or guides, use pipefittings with IP55 degree of protection or higher;

The electric system upstream of the opener shall comply with current regulations;

This opener is not intended for use by persons (including children) whose physical, sensory or mental abilities are reduced, or who have lack of experience or knowledge, unless under supervision of a suitable person;

Children should be supervised to make sure they do not play with the device;

WARNING - The packaging material of all components should be disposed in compliance with local regulations.

WARNING - The data and information provided in this manual are subject to change at any time without notice.

2 - PRODUCT OVERVIEW

2.1 Description of the product









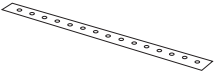
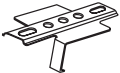
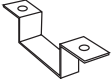
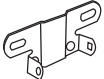

Forza is an electromechanical reversible gear motor, suitable to automate sectional doors up to 16 m². Forza has a built-in encoder, control unit and receiver.

The receiver can be set to select fix or rolling code transmitting devices.
The guide rail is belt driven, pre-assembled in one or three pieces.

2.2 Parts list

The system for garage door automation is composed of two boxes. One contains the opener motor; the other contains the guide rail assembly, as shown in the illustration below.

Parts List

Part	Name	Quantity
	Opener Motor	1
	Instruction & Installation Manual	1
	Curved arm for door	1
	Mounting plate	2
	Guide Rail Support	1
	U bracket	3
	Guide Rail Mounting Bracket	1
	Door bracket	1
Package of Fasteners		
 (8 off) - 6x15 hex-head self-tapping screw	 (1 off) - 6x80 Screw with hex nut	
 (1 off) - 8x25 Hinge pin	 (1 off) - 3x20 Split pin	 (1 off) - Drive Spacer
 (6 off) - 6x80 Expansion plug	 (4 off) - 8x20 Screw with hex nut	

Guide Package

Pre-assembled Guide Rail

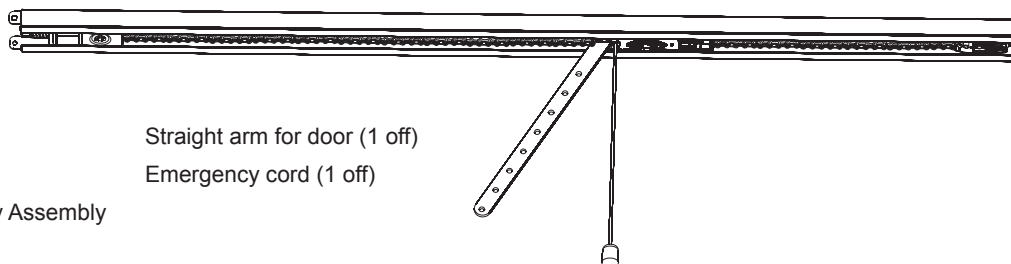

Guide Rail (1 off)

Belt (1 off)

Carriage or Trolley Assembly (1 off)

Straight arm for door (1 off)

Emergency cord (1 off)

2.3 Specifications

CODE	DESCRIPTION	FORCE	GUIDE RAIL
SEZ12SL	for sectional doors up to 16 m ² with motor 24 Vdc and control unit with built-in receiver	1200N	belt driven pre-assembled 3320 mm in one piece

TECHNICAL DATA	SEZ12SL
Input Voltage	190V - 240V
Power	24 Vdc
Consumption power	160 W
Motor consumption	6,66 A
Protection degree	IP 43
Force	1200 N
Speed	11 cm/s
Stroke	2,8 m
Light	25 W (1x) E14
Max door size	16 m ²
Working cycle	60 %
Working temperature	-20° + 55° °C
Weight	11 Kg

LIMITS OF USAGE

Sectional Door Dimensions

H max = 2,7 m

W max = 5.9 m

m² max = 16 m²

output power for accessories 24V/800 mA

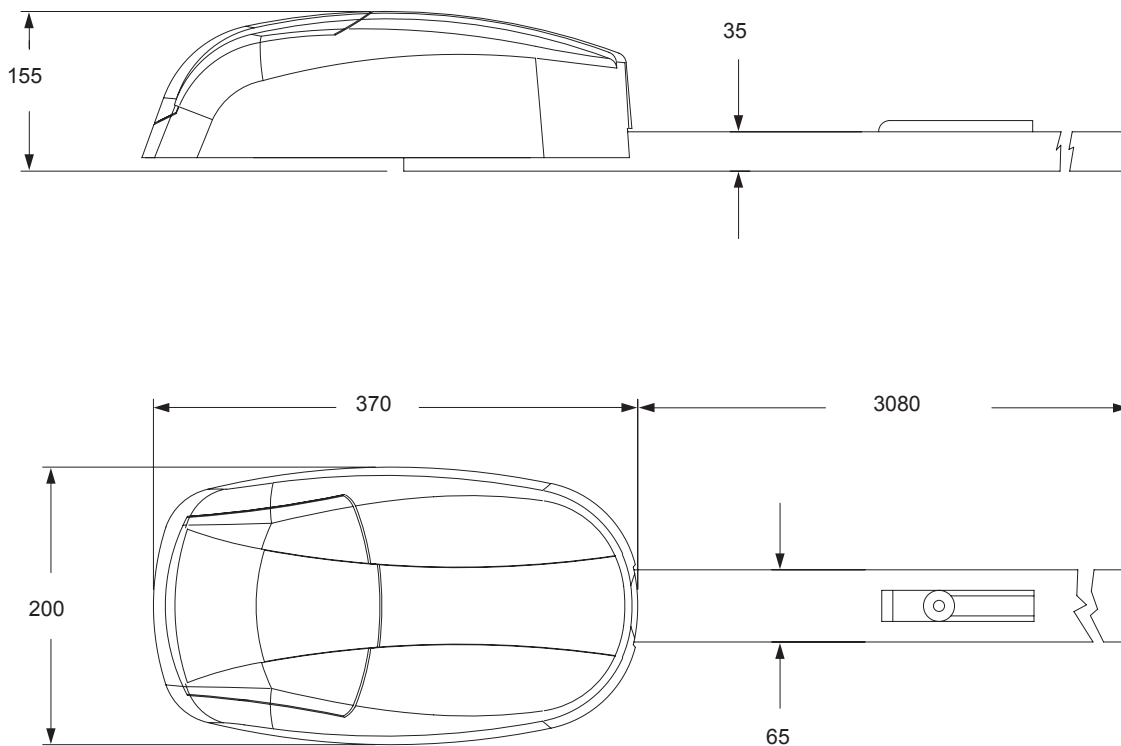

2.5 List of Cables Needed

Typical installation cables required for connection of various devices are shown in cables list table.

The cables used must be suitable for the installation.

CABLES LIST TABLE

Connection Distance	from 1 to 10m	from 10 to 20m	from 20 to 30m
Transmitter photocells	2 x 0,5mm ²	2 x 0,5mm ²	2 x 0,5mm ²
Receiver photocells	4 x 0,5mm ²	4 x 0,5mm ²	4 x 0,5mm ²

3 - PRELIMINARY CHECKS

Before installing this product, verify and check the following steps:

- Check that the door is suitable for opener
- The size of the door must be within the operating limits specified for the automation where the product is installed
- Check for conditions of high acidity or salinity or proximity to heat sources that may cause malfunction of the product
- Check if extreme weather conditions (for example the presence of snow, ice, high temperature range, high temperatures) may increase the force required for the opening/closing operation.
- Check that the manual operation of door is smooth and friction-free and operates correctly

- Check that the door is balanced and generally stationary if left in any position

- Ensure that all materials used for the installation comply with current regulations

4 - PRODUCT INSTALLATION

4.1 Assembly of Guide Rail in 3 Parts

1. Line up the three pieces of the guide rail
2. Slide connector over the next piece of guide rail until the limit positions can be seen on both sides of connector. Bend the tabs with screwdriver to retain connector. Repeat for second connector.

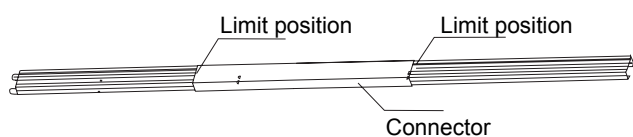

3. Tighten the nut with a wrench $\varnothing 13$

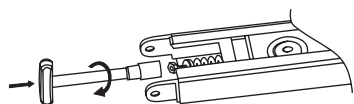

4. Adjust as indicated in the below diagram

For a correct adjustment ensure that during movement of the door the belt does not slide out of the tracks (too loose) or on the contrary tends to bend the tracks (too tight)

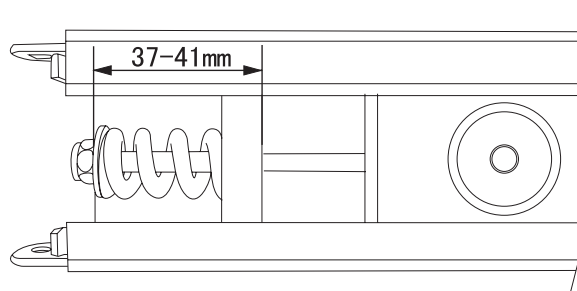

4.2 Connection of the Motor Body to the Guide Rail

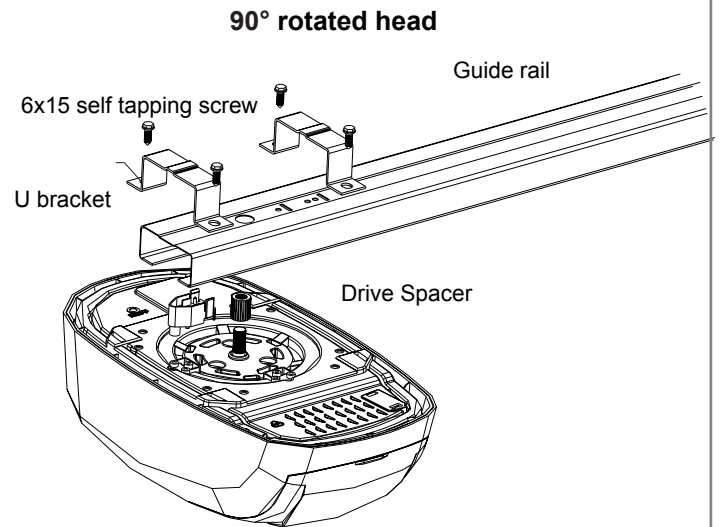
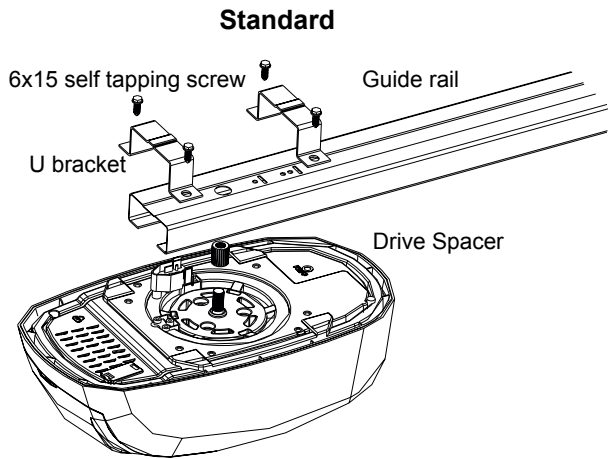

4.3 Installation of the Guide Rail and Motor on the Door

Position the guide with reference to below

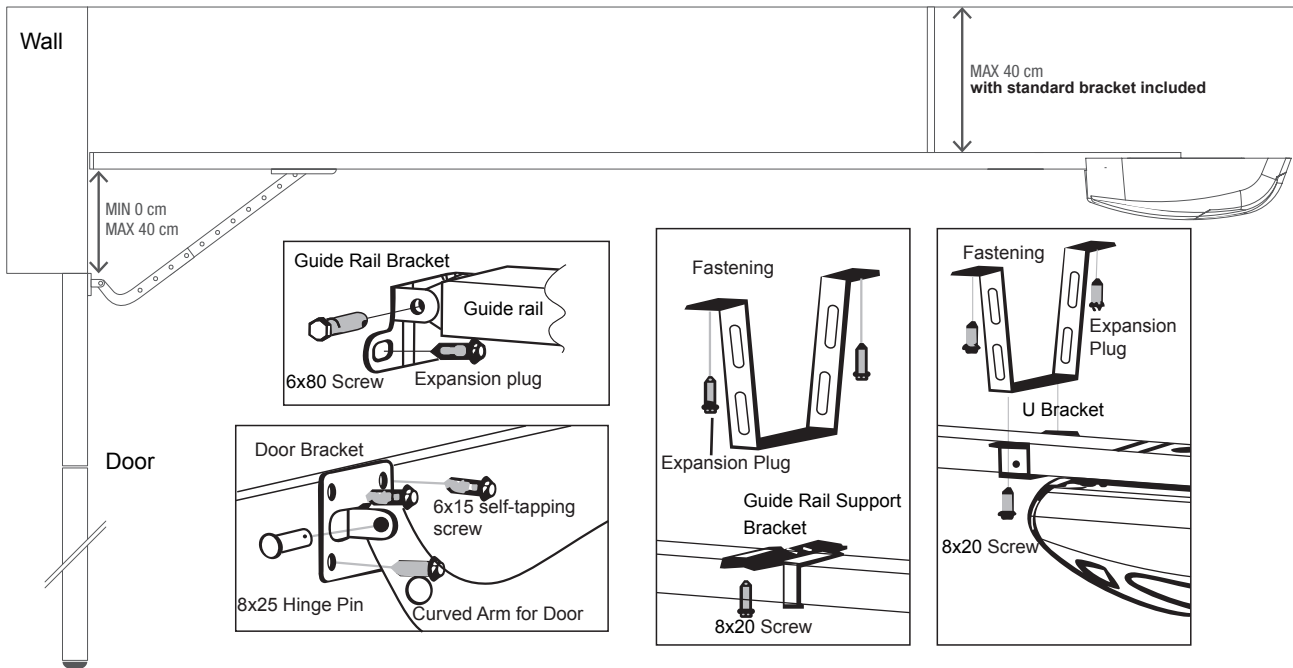

4.4 Manual Opening of Door

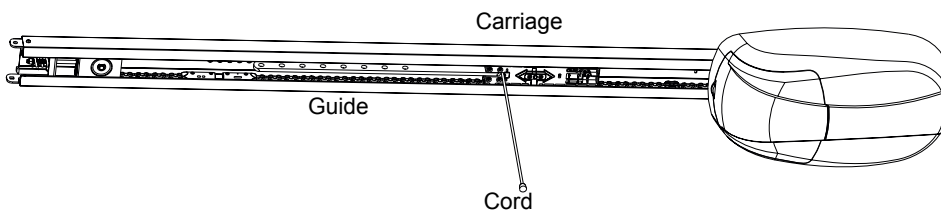

In case of power failure

Pull cord and move door to release carriage assembly. Open/close door manually

4.5 Wiring Diagram

WARNING - Before making connections verify that there is no power to opener
Wiring diagram for optional photocells and Open/Stop/Close command (O/S/C).

Photocells must be fitted by qualified personnel. Remove factory bridge across connections 4 & 5 prior to wiring photocells.
 O/S/C must be connected between no. 2 and no. 1 (contact normally open N/O)

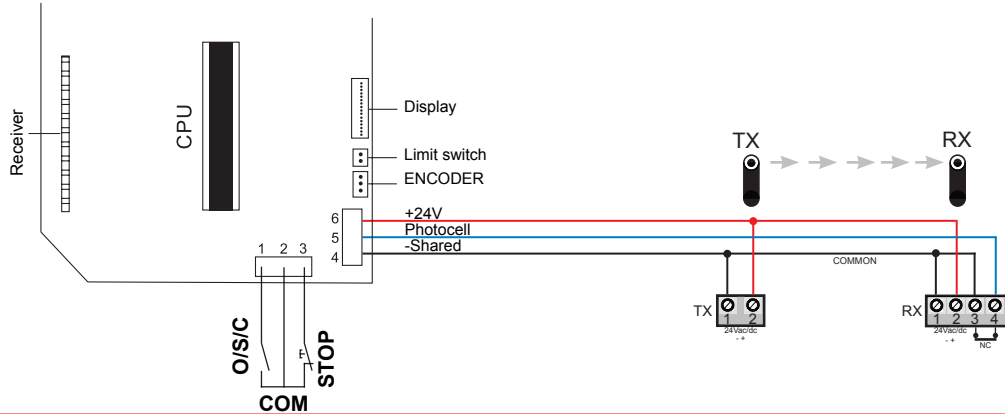

4.6 Normal Mode LCD Display

In "NORMAL MODE", when the installation is powered normally, the right hand digit of 2-digit LCD displays rotates and after 30 sec. will turn off

Swirls around

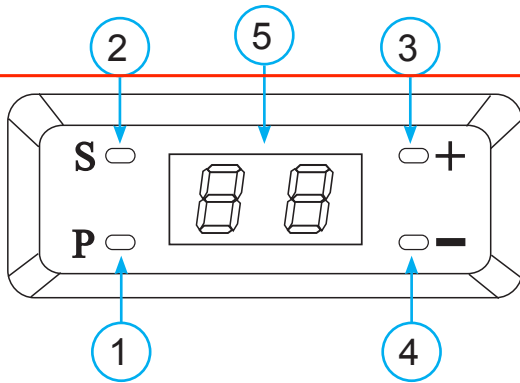

Description of the buttons

- 1 - P function button
- 2 - S setting up remote transmitters
- 3 - + parameter increase button
- 4 - - parameters decrease button
- 5 - Display

4.7 Programming

- Preparation A. Gently move the door to ensure carriage is engaged on guide rail (door should be in closed position).
- B. Power on. The light will turn on, the unit provides a single audible signal and the display indicates "0".

Attention: If programming is not complete, the settings will be cancelled automatically. If incorrect setting has been programmed, power off and then power back on, following steps below.

Warning: Programming of functions from 4.7.1 to 4.7.3 are mandatory. It is possible to end the programming phase and save data in any step on the functions menu from 4.7.3 to 4.7.9. Refer Step 4.7.10.

4.7.1 Setting of Opening Limit

Warning: the saved information has no effect if this procedure is used for setting the limit of closing

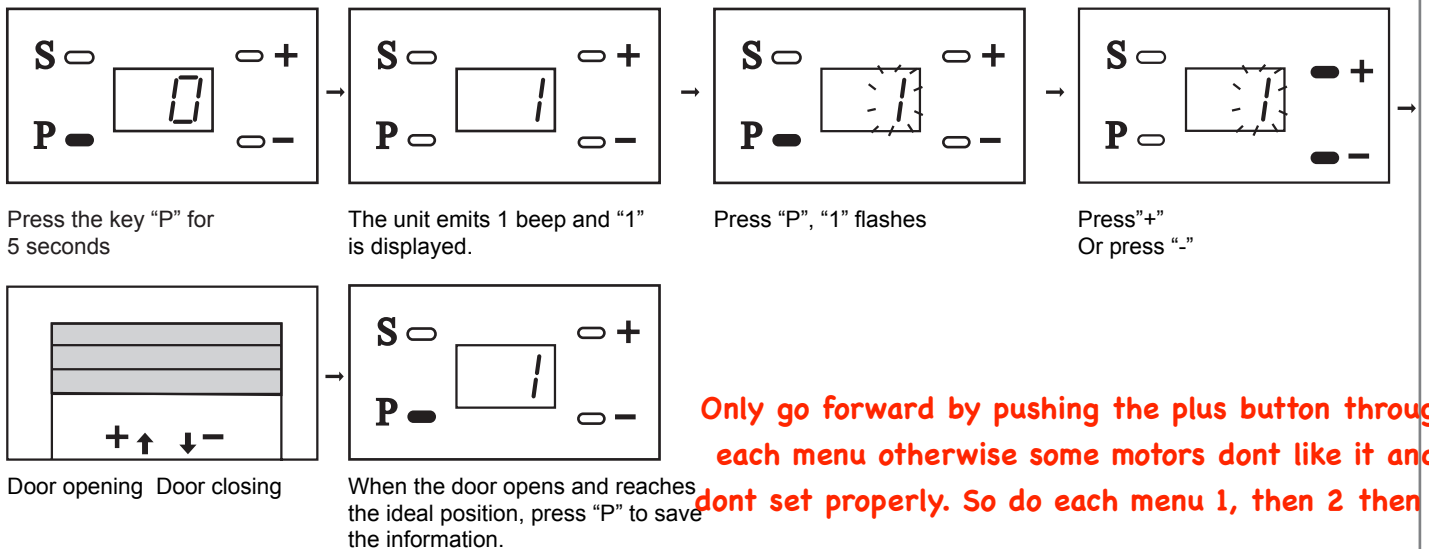

Only go forward by pushing the plus button through each menu otherwise some motors dont like it and dont set properly. So do each menu 1, then 2 then 3.

4.7.2 Setting of Closing Limit

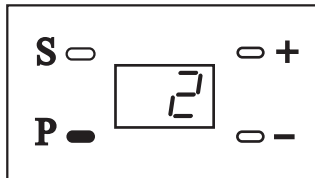
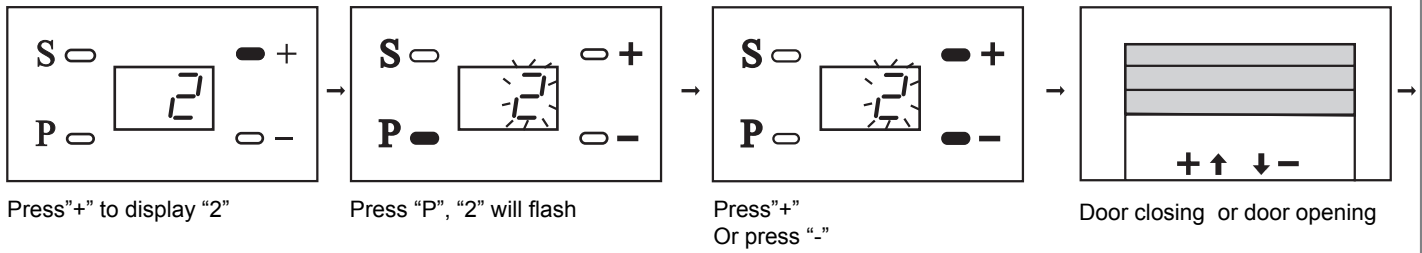

When the door closes and reaches the ideal position, after 2 seconds press the key "P" to save the information.

This is just saying dont close the door down hard when setting the liomits

Note: In order to avoid activating the obstacle safety system in setting the closing limit it is strongly it is strongly recommended to release the button as soon as the door touches the ground.

Activating AUTO FORCE LERNING MODE. has to be done.

4.7.3 Force Learning Activation

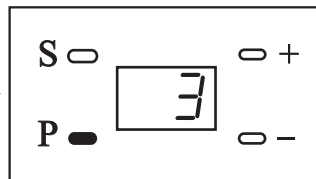
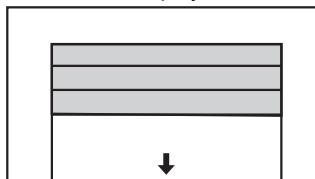
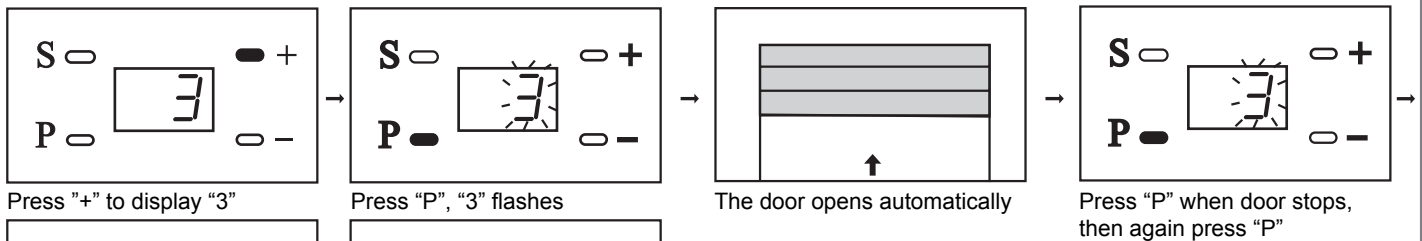

To EXIT STRAIGHT AFTER DOOR CLOSES you have to push and HOLD THE P BUTTON or it will go through force setting again

or
 Press and hold "P" for 5 seconds to save the settings and exit programming

Note: If "P" is pressed to save setting and then you wish to save & exit programming, please proceed to first step of 4.7.4 and then press & hold "P" for 5 seconds. Otherwise saving & exiting after saving the closing setting will trigger door to open again, however all parameters are saved and display will revert to Normal Mode. Door can be closed by pressing "-" button.

4.7.4 Setting Force Level

If you wish to over-ride the settings from step 4.7.3 follow this step. Note: To exit the programming and save the parameters push P button for 5 seconds.

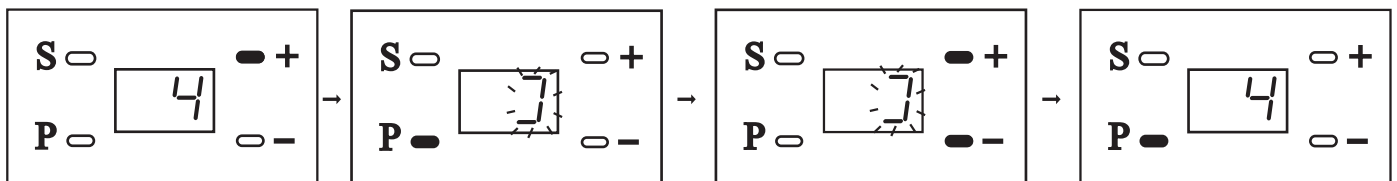

When programming is finished the door must make a full cycle before usage, this cycle is used to learn the force after the modification made.

4.7.5 Setting Reception Mode

This step is not required if using a 'Forza' remote transmitter. Default setting is "1".

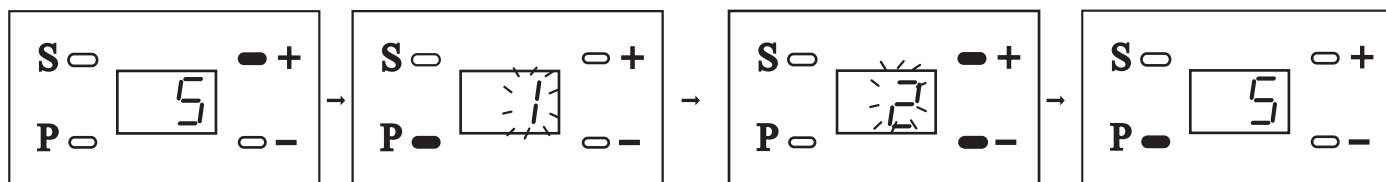

Press "+" to display "5"

Press "P", on the display "1" flashes, to indicate that the set radio decoding is ROLLING CODE (default setting); if 2 is selected on the display the set radio decoding is FIX CODE

Press "+" or "-" to select the desired type of decoding

Press the key "P" to show "5", and save the settings.

Note: To exit the programming and save the parameters push P button for 5 seconds.

4.7.6 Photocell Function Setting

Through this function with the door closed and photocell interrupted, it is possible to enable/disable the opening command (Default setting is "0")

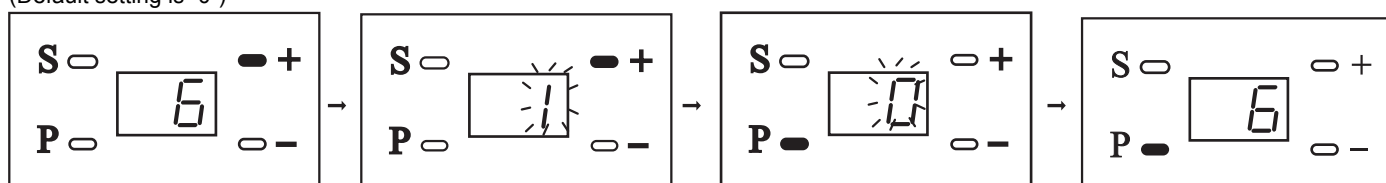

Press "+" to display "6"
Photocell is always active in closing

Press "+", the display shows 1, to indicate that the photocell is active during opening

Press "P", the display shows 0, to indicate that the photocell is not active during opening (default setting)

Press "P" again to save the settings

Note: To exit the programming and save the parameters push P button for 5 seconds.

4.7.7 Setting of the Duration of Automatic Closure

For safety reasons this setting should only be used with the optional photocell beam. (Default setting is "0")

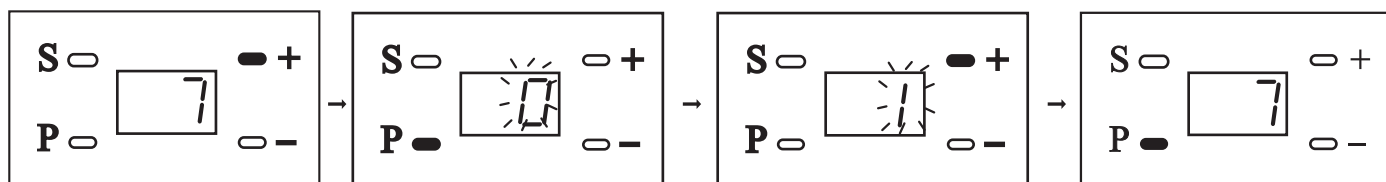

Press "+" to display "7"

Press "P" to show "0", the function is not active (default setting)

Press "+" to show "1" and activate the function. This setting activates automatic closing after 5 seconds.

Press "+", or "-" to select the duration following the table below
Press "P" again to save the settings.

Value	0	1	2	3	4	5	6	7	8
Time	not active	5 sec	10 sec	20 sec	30 sec	60 sec	120 sec	180 sec	240 sec

Note: To exit the programming and save the parameters push P button for 5 seconds.

4.7.8 Setting of Alarm for 2000 Operating Cycles

(Default setting is "0")

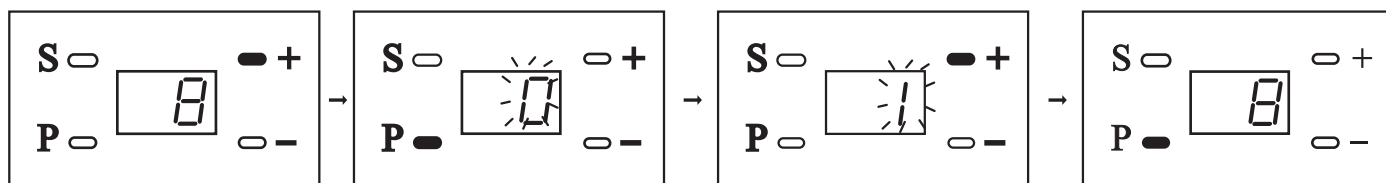

Press "+" to display "8"

Press "P". The display shows "0" to indicate that the function is not active (default setting)

Press "+". The display shows "1" to indicate that the function is active

Press "P" again to save the settings

Silencing the acoustic alarm: power off, then power on again, or press the door control keys either "+" or "-" for 5 seconds

Note: To exit the programming and save the parameters push P button for 5 seconds.

4.7.9 Opening Command Setting

For safety reasons this setting should be used in conjunction with optional photocell beam. Default setting is "0". It is possible to change the functioning of the open/stop/close step by step command to only open

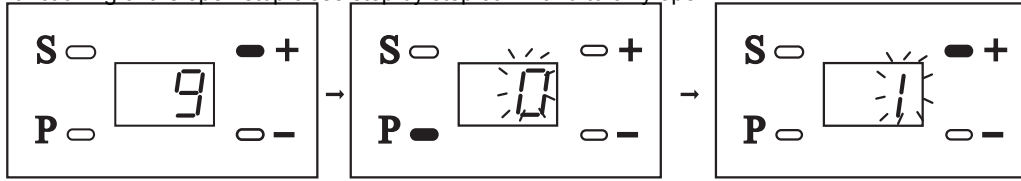

Press "+" to display "9"

Press "P", the display shows "0" to indicate that the step/step command has the Open/Stop/Close function (default setting)

Press "+", "1" appears to indicate that the step/step command can only open

By enabling this function, the Step/Step command permits opening by accepting only re-opening during closing. With step 4.7.7 set at "1" or more automatic closure enabled at each command the automatic closing time is updated. With step 4.7.7 set at "0" automatic closure disabled with the door open it is possible to re-close it using the step/step command

Note: To exit the programming and save the parameters push P button for 5 seconds.

4.7.10 End of Programming

Warning: programming of functions from 4.7.1 to 4.7.3 are mandatory. It is possible to end the programming phase and save data in any step on the functions menu from 4.7.3 to 4.7.9 by taking following steps:

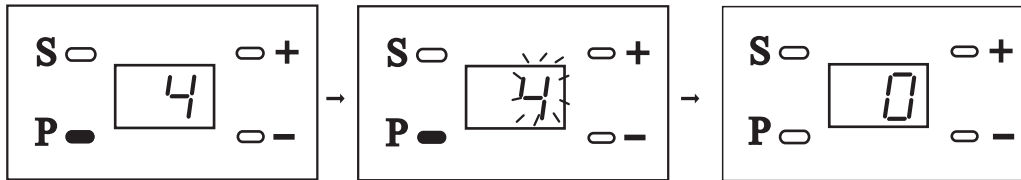

To exit after any parameter from 3 to 9 (eg. step 4) press and hold "P" for 5 seconds

Modifications made before this step will be saved

A beep followed by a sliding "0" indicates that the programming procedure has concluded successfully

4.8 Saving & Deleting Remote Transmitters

Follow the procedure below to memorize ROLLING CODE transmitters. To save FIX CODE transmitters follow the paragraph 4.7.5, then after memorize transmitters as indicated here below.

1. Saving or Adding Remote Transmitters

- Press the S button until "0" appears
- Release the S button
- Press the button of the transmitter to be memorised
- The "0" on the display disappears, the transmitter has been saved
- For each transmitter (maximum 20) repeat the procedure for each single transmitter

4. Wall switch and courtesy light programming

- Push S button until "0" appears
- Release S button
- Push S button again until "0" starts to flash
- Release S button
- In order to switch on the courtesy light push the remote control button or wall switch button to be memorized

N.B: Once activated the courtesy light will stay on for 180 sec; in case of reactivation the courtesy light counter will re-start from zero. It is possible to memorize just one button with the courtesy light function.

BUZZER SIGNAL	MEANING
1 beep	code memorized
2 beeps	code already memorised
3 beeps	memory full

2. Deletion of a single transmitter

- Press and hold both the P & S buttons for the next two steps
- Press the button of the transmitter to be deleted until the control unit emits a beeping sound
- Release the transmitter button
- This procedure will delete all the buttons regarding that transmitter

3. Deletion of all transmitters

- Switch off the 240 Vac power supply
- Press and hold the S button
- Switch on the 240 Vac power supply while holding the S button for 5 seconds until you hear the 2 beeps from the control unit

4.9 Troubleshooting

Following is list of some malfunctions that may happen.
The LCD screen will also show some malfunction codes.

Problem	Causes	Solution
The opener does not work	1. The electrical plug is not inserted firmly 2. The fuse is blown	1. Check plug. Contact electrician if power point faulty 2. Contact electrician to replace fuse with same fuse type
The range of the transmitter is excessively limited	The battery is low on power	Replace the battery with a new one of the same type
The drive belt moves, but the door does not move	The carriage system is disengaged	Lock the carriage as per Step 4.4
The alarm continues to sound	Alarm: 2000 cycles of operation	Disconnect the power supply, then power back on
The door is not in position when it is opened or closed, or it does not work	Incorrect setting	Re-program opener again
The door does not work correctly, and the screen shows "H"	Control unit problem due to high humidity	Dry the unit (request assistance from a technician)
Sudden interruptions or jerks in the operating system, and the screen shows "F"	1. The tension spring is loose or out of adjustment 2. Obstacle safety system activated with no obstacle 3 The power supply is not stable	1. Adjust the traction spring. 2. Adjust the force setting (step 4.7..4) to the suitable level until "F" disappears 3. Contact electrician to check power supply
During operation, you can hear a screeching noise	Lack of lubricant between the guide and carriage after a long period of use	Lubricate or grease the point between the guide rail and the carriage

5 - FINAL TESTING OF THE OPENER

The testing of the opener should be performed by qualified technicians.

All installed components should be tested following the procedures outlined in this instruction manual

Check that they meet the guidelines in Chapter 1 - Safety warnings
Check that the door can move freely once the automation is disengaged, and that they are balanced and generally stationary if left in any position

Check the correct operation of all connected devices (photocells, etc.), testing the opening, closing and stopping of the door via the connected control devices (transmitters, buttons, switches)

Carry out an obstacle test using a block of 50mm wood on floor underneath door to ensure the door reverses on hitting the obstacle. adjust force setting, if required, to ensure safe operation of door

Ensure this manual is given to the end user of door.

Attach the label indicating the steps required to manually dis-engage the opener

Make sure the end user understands properly the automatic, manual and emergency operation of the opener.

WARNING - after detecting an obstacle, the door stops and reverses, the automatic closing function (if set) will not operate. To restore this function press wall button or remote transmitter to close door.

6 - BATTERY BACKUP CONNECTION

Forza opener can also function in the absence of main power supply by installing the optional external Battery Backup Model 900KBPK without making any modifications to the system.

IMPORTANT: If using battery backup with optional photocells, it is necessary to connect the power of the photocells in the connectors CH+ and CH-.

Connection sequence:

- Disconnect the 240 VAC power supply
- Connect 900KBPK to terminals CH+ and CH- .
- Re-connect the mains power supply
- New batteries charge up after about ten hours.

7 - INSTRUCTIONS AND WARNINGS FOR THE END USER

Each installation is unique and only your installer has the experience and professionalism required to create an installation to suit your needs, is safe and reliable over time, and carried out according to the good industry practice, i.e. compliant with the current regulations. Even if your opener meets the security level required by law, this does not exclude the existence of "residual risks", i.e. the possibility that it may cause dangerous situations, usually as a result of improper or irresponsible use; for this reason we would like to give you some suggestions:

- Before using the opener for the first time, ask the installer to highlight any potential of risks.
Keep this manual for future use and deliver it to any new owner of the opener.
- Inappropriate or improper use of the opener can make it dangerous: do not operate the opener if people, animals or obstacles are in its range.
- Children: If properly designed, the opener ensures a high degree of security, preventing movement in the presence of people or things with its detection systems, and ensuring always predictable and safe activation. It is prudent to prevent children from playing near the opener and keep wall switches and remote transmitters out of their reach to prevent accidental activation.
- Malfunctions: As soon as you notice any malfunctions, disconnect the installation from the power supply and operate the manual release. Do not attempt any repairs by yourself, but seek the assistance of qualified personnel. In the meantime the door should be operated manually until the malfunction is fixed.

- In case of power failures: if the installation is not equipped with backup batteries, the opener can be operated as a manual door. To do this, you must dis-engage the carriage on guide rail.

- Maintenance: Like any machine, your opener needs periodic maintenance to ensure its long life and total safety. Boss Openers recommend a frequency of 12 months for normal domestic use, but this period may vary depending on the intensity of use. All inspection, maintenance or repairs should be performed only by qualified personnel.

- The end user should periodically clean the covers of the photocells (clean only with a cloth slightly dampened with water), as well as the remove of any obstructions, should as leaves or rocks that could block the operation of door. To prevent anyone from activating the door, before proceeding, remember to dis-engage the opener.

Replacing the remote transmitter battery: if your remote transmitter range is reducing over time, or not work at all, this may mean battery is low on power (depending on use, it may take several months to over a year). In that case, you will see that the light on remote transmitter does not turn on, or comes on only briefly. Replace battery with same type, or equivalent type to one installed.

NOTES

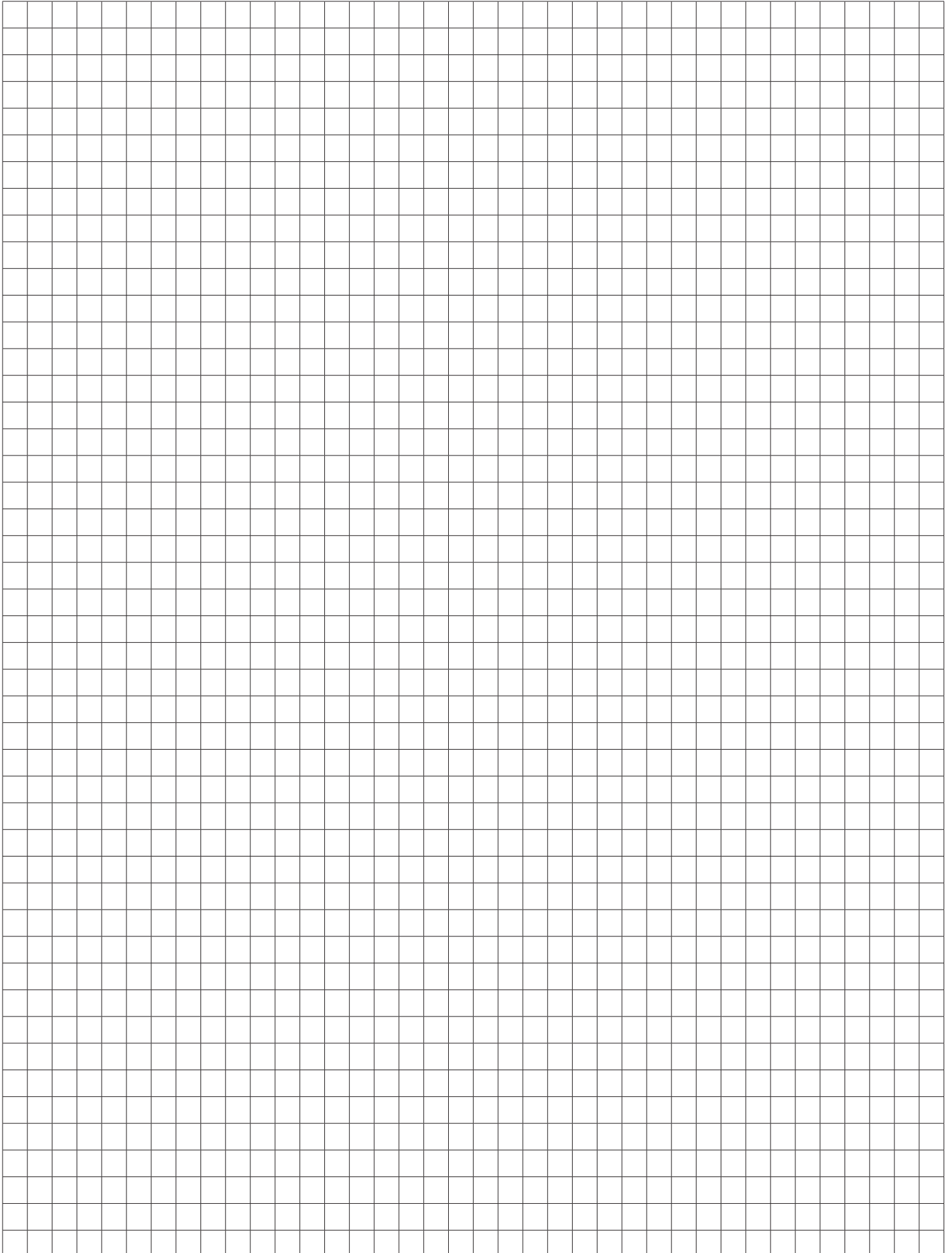

8 - DECLARATION OF CONFORMITY

DECLARATION OF CONFORMITY "CE"

The manufacturer: **Key Automation S.r.l.**

Address: Via Alessandro Volta, 30 - 30020 Noventa di Piave (VE)

DECLARES THAT THE FOLLOWING EQUIPMENT

Description: Sectional gear motor for garage automation

Model: **FORZA**

Code: **SEZ12SL**

Is in conformity with the following community (EC) regulations:

Machinery Directive 2006/42/EC
Low Voltage Directive 2006/95/EC
EMC Directive 2004/108/EC

Is in conformity with the following harmonized standards regulations:

EN 55014-1 + EN 55014-2
EN 61000-3-2 + EN 61000-3-3
EN 60335-1 + EN 60335-2
EN 55022

He declares, moreover, that it is not allowed to use the above mentioned product until the machine, in which this product is incorporated, has been identified and declared in conformity with the regulation 2006/42/EC.

Il Rappresentante legale
The legal Representative
Nicola Michelin

Phone: 07 3713 3200

Email: enquiries@bossoperators.com.au

Instruction version
580ISFORZA REV.01