



GRIFCO

STANDARD OPERATOR

Universal Installation & Users Manual

Rev: 505003

(For electrical installation only, go to page 5)

Contents:

Introduction	Page 2
Identifying your Maestro Kit	
Installation	Page 3
Mounting The Unit	
Connecting Power	Page 5
Controller	Page 6
Installing Controller	
Getting Started / Setup	Page 7
Checking Power and Door Direction	
Changing Door Direction	
Setting Limits	Page 8
Operation	
Door Behaviour and Obstruction Detection Inputs	Page 9
Setting Door Behaviour	
Obstruction Detection Devices	Page 10
Optional Third Limit	
Main Controller Board (MCB)	Page 11
Accessories	Page 12
Remote Control Card & Transmitter	
Other Controller Options	
Mini Expansion Board	Page 13
ELITE Expansion Board Upgrade	
Troubleshooting / Status Table	Page 14
Maintenance	
Overload Adjustment	Page 15
Warranty	Page 16

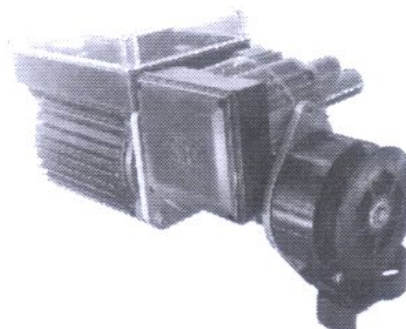

**Grifco Advanced Users
QUICK START GUIDE**

CONNECTING POWER

- Open enclosure
- Feed leads through conduit entry
- Attach power leads to correct positions on power terminal block according to motor type (Refer page 5)
- Connect controller using 6 metre cable (RJ45 sockets)

IF DOOR'S MOVEMENT IS BACKWARDS:

- While holding set, press the stop button 3 times
- The limit indicator will flash
- Hold stop for 10 seconds until limit indicator flashes
- Press stop to exit

TO SET LIMITS

- While holding the STOP button, press and release the SET button 3 times
- The limit indicator will flash
- Move door into closed position
- Press SET
- Move door into open position
- Press SET

For a more detailed explanation on installation, setup, and operation please read booklet

Introduction

Congratulations on your purchase of the Grifco Maestro Industrial Operator unit. The Maestro is a state-of-the-art operator using sophisticated digital electronics and a robust gear head that provides a balance of user friendly operation and high level technology.

The new Maestro series begins a revolution in electronic control flexibility and functionality for industrial doors.

Identifying your Maestro kit

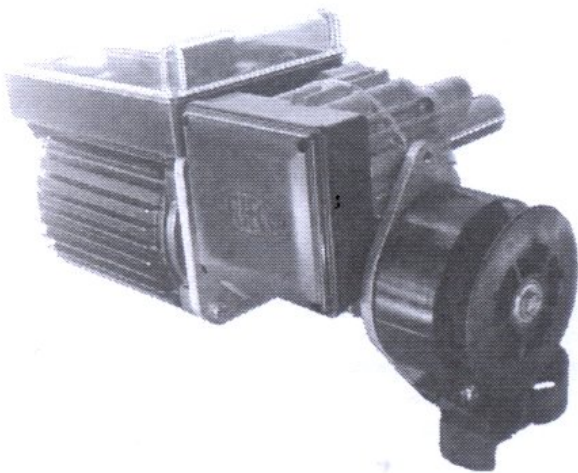

Maestro Operator



Controller

- Mounting bolts, controller cable and glands (2) are also included as part of the standard Maestro Operator.

Appearance may vary with different motor, gearbox and controller types.

Installation

Mounting the unit

The Maestro is typically flag mounted below the door drum so that the operator shaft points toward the door opening and lies beneath the sprocket of the door drum. For mounting you will need to either secure the operator to the roller shutter head plate with prepared holes or slots, or use a mounting plate that will need fixing via a wall angle or similar existing fixture.

When assessing and selecting an appropriate mounting location, the following considerations should be taken:



Mounting plate slots allow the chain tension to be adjusted through vertical movement of the operator

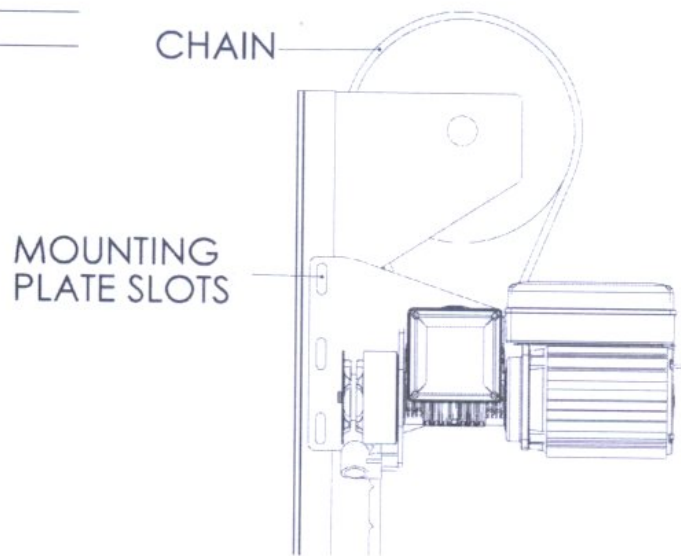
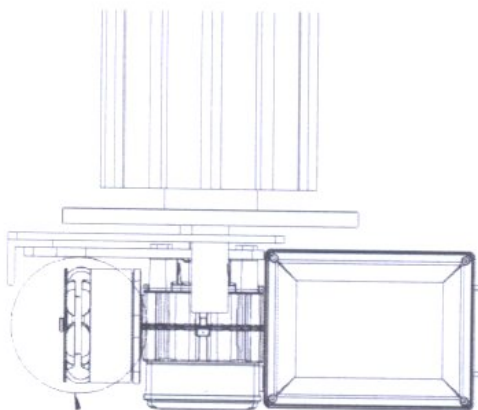

Clear path for manual chain to hang downward (see left)

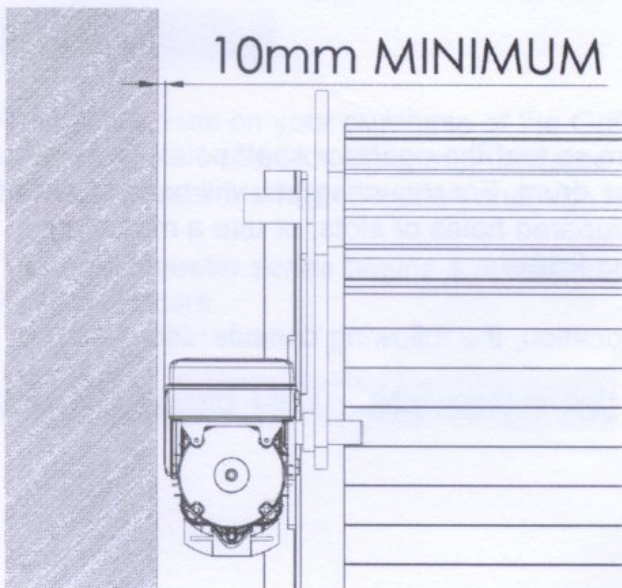

Side room to imposing structures (see left)

Note: The Maestro encoder housing is not a serviceable area and can be located within 10mm of an imposing structure without affecting installation.

Limited head room to ceiling (see right)

Note: The Maestro main control housing is a serviceable area and will need to be accessed by service personnel. See * below for options of how to overcome problems in which sufficient head room is not available.

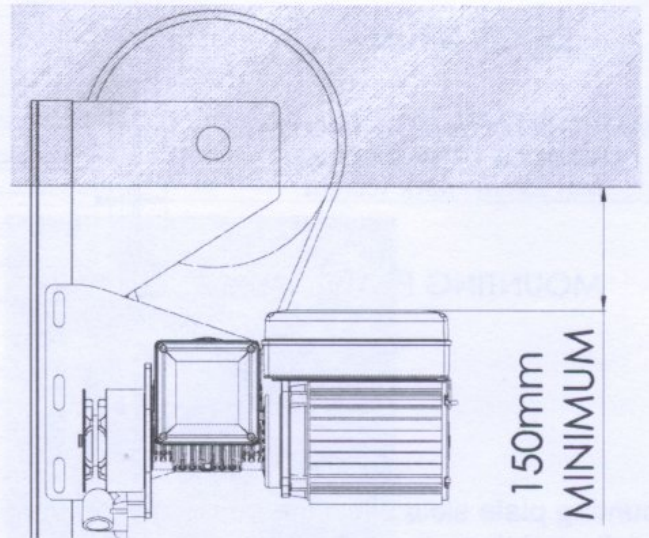

MAX LENGTH 6 METRES
(INC DISTANCE TO SOCKETS)

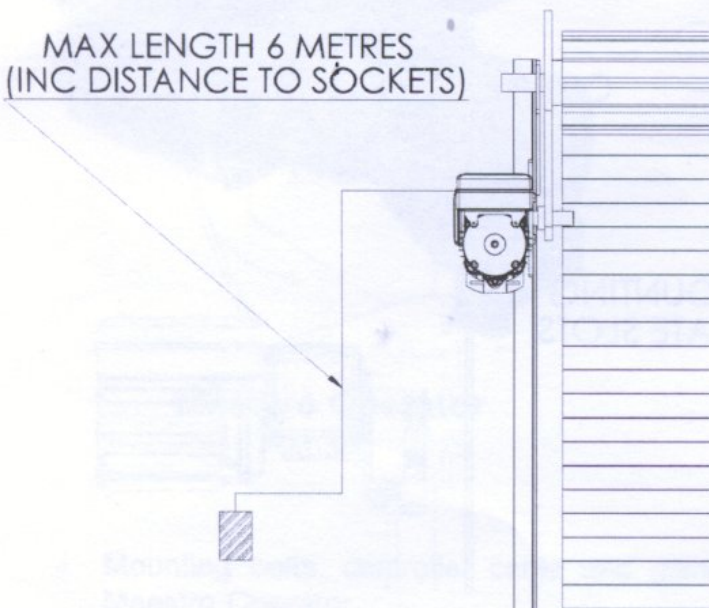

* If there is insufficient room above the Maestro operator to allow servicing then a Grifco Wall Mount Kit (Part No. WMK1) or Grifco Rotation Bracket (Part No. RBK1) can be used to reposition the main control housing. Please contact your local roller shutter dealer or Grifco for more information.

Location of Controller (see left)

Note: Controller has 6 metres of cable with plug ends ready to connect the Maestro Operator to the Controller.

When Securing the Maestro Operator with the 4 x M12 x 40mm long fasteners (based on a 8mm mounting plate) and spring washers provided, it is critical to ensure that the applied torque is between 80-90Nm. When mounting through thicker sections, ensure a minimum of 30mm of screw thread is engaged with the female thread. Use of incorrect fasteners or torque may cause serious product damage and/or personal injury. When fixing through a slotted plate, ensure that the slots are no wider than 13mm as a spring washer may not be adequate in outside diameter to support the hexagon head.

Connecting Power

The Maestro Operator is available in both single and three phase models. The operator model can be identified by the label located on the MCB contactors. Carefully match the wiring of the operator to the correct configuration shown below.

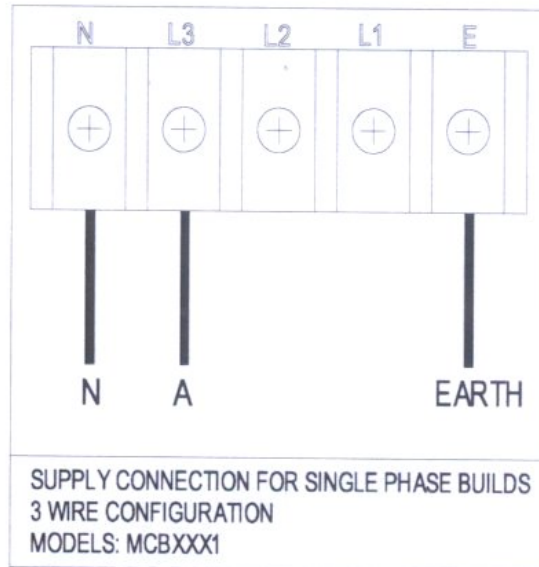
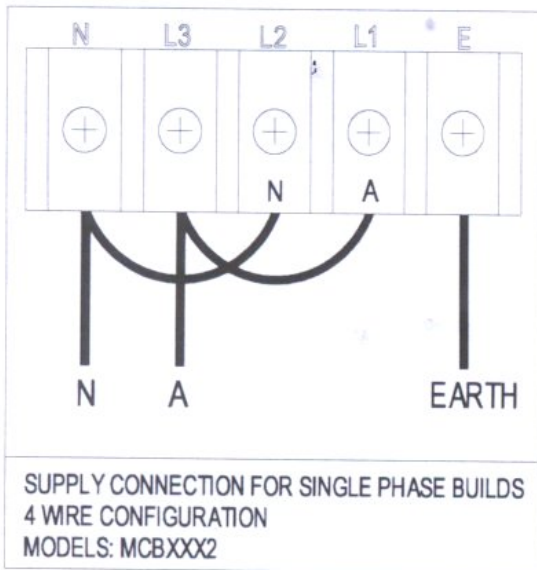
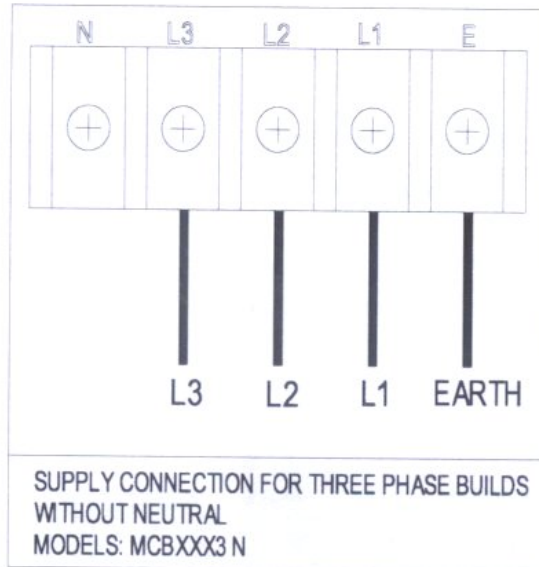
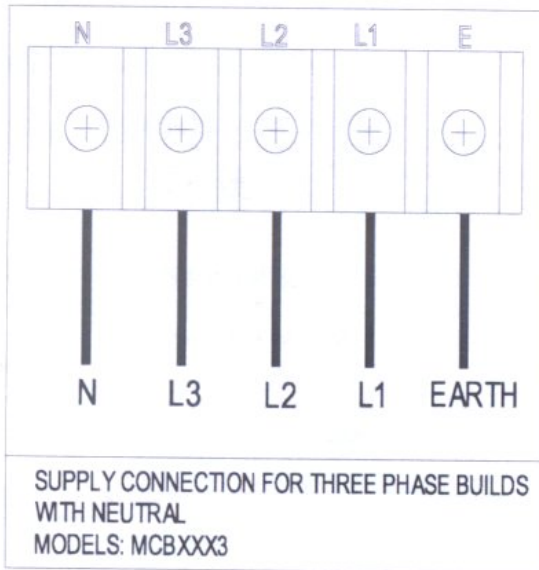

It is recommended that 1.5mm²(max.) wire size is used to avoid unnecessary crowding and difficulty when making connections. Avoid lengthy cable ends that may cause undue pressure on delicate components. Place any labels or tags (example below) on any switch providing power to the operator, including isolating switches, circuit breakers and general power outlets.



Controller

The Maestro Controller is the user interface for Operator. It consists of 4 buttons to control and program the unit as well as 3 indicators to display the operator status.

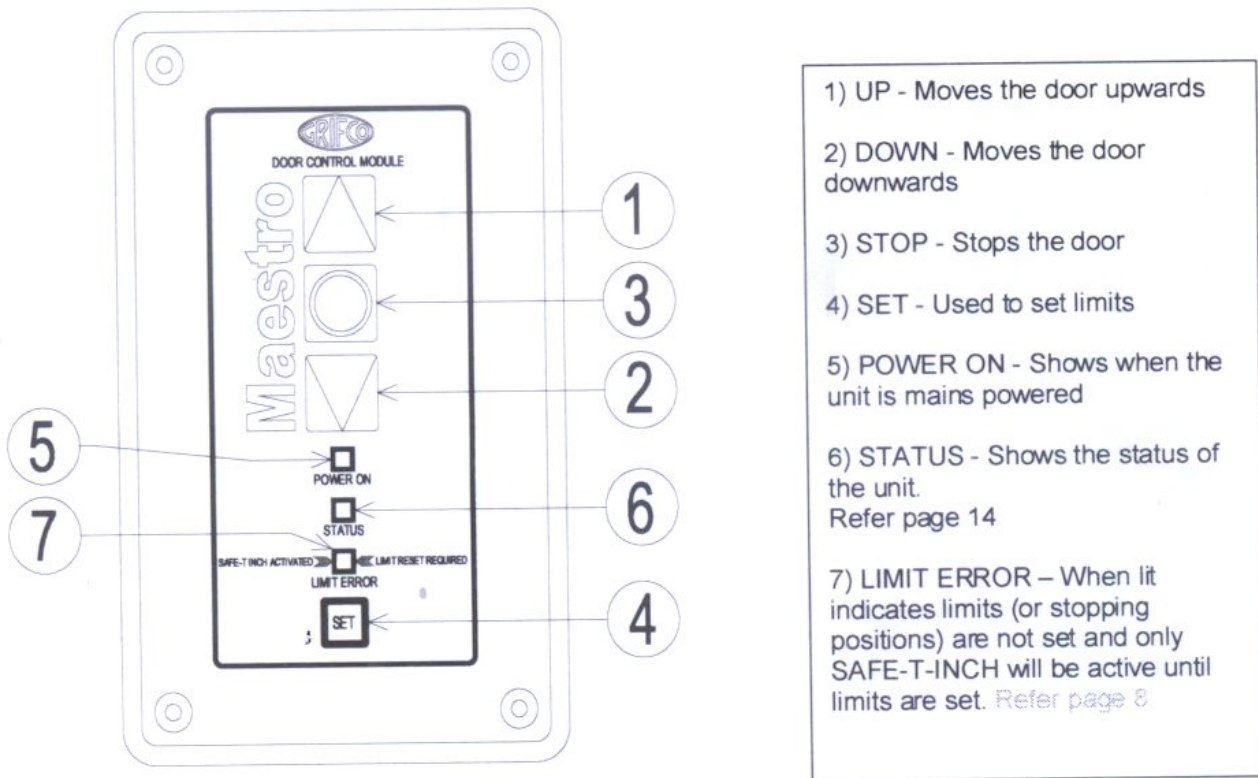

- 1) UP - Moves the door upwards
- 2) DOWN - Moves the door downwards
- 3) STOP - Stops the door
- 4) SET - Used to set limits
- 5) POWER ON - Shows when the unit is mains powered
- 6) STATUS - Shows the status of the unit. Refer page 14
- 7) LIMIT ERROR – When lit indicates limits (or stopping positions) are not set and only SAFE-T-INCH will be active until limits are set. Refer page 8

Installing the Controller

The Controller is connected to the MCB via a low voltage control cable provided. Using the glands provided, you may choose to run the cable "as is" and route neatly down the wall of the building, or otherwise use conduit for a heavier duty finish.

To connect the Controller to the Maestro operator, identify the most appropriate entry of the MCB enclosure for your installation. Open the MCB enclosure and fit the applicable gland or conduit fitting, allow the cable enough length to reach the controller port. Place the opposing end of the control cable through the conduit entry of the Controller Enclosure and pull through any excess cable. Plug the RJ45 plug into the port located within the Controller assembly using the space provided within the Controller enclosure to store any excess cable.

Note: If the supplied 6m controller cable is not long enough for your installation, use a Grifco Controller Extension Kit, available from your local Roller Shutter dealer or Grifco (Part No.ESK01).

A sticker outlining the limit setting instructions has been included with this manual. It is recommended that this sticker be placed in or around the controller as a quick reference for users.

TO SET OPEN AND CLOSED DOOR POSITIONS:

- While holding the STOP button, press SET button 3 times
The limit indicator will now start flashing slowly.
- Position the door at the closed position and press SET
The limit indicator will flash quickly, then resume to a slow flash.
- Position the door at the open position and press SET
The door is now ready for use.

Getting Started / Setup

Once the installation of the motor, gearbox and control unit is complete it is time to test the unit. Make sure the door is at least 300mm from the ground and the top door stops. This will prevent damage to the door if the direction of the operator is reversed.

CHECKING POWER AND DOOR DIRECTION

1. Ensure the unit is powered by checking that the *POWER ON* "red" indicator on the controller is lit. You should also notice that the *LIMIT ERROR* "orange" indicator is lit which signifies that there are no limits set yet. Please refer to *Setting Limits* section on the next page for details.
2. Check the direction of the doors movement. Depending on the orientation and the wiring of the unit, the direction of door movement may be the opposite of what is shown on the control box.

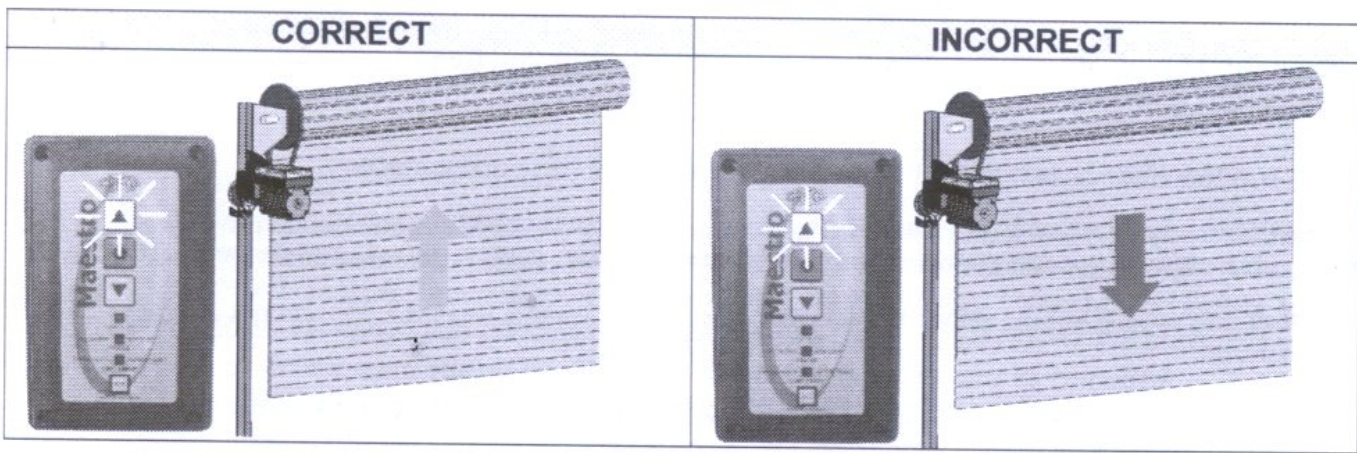

If the direction is incorrect continue through section *Changing Door Direction*. If the direction is correct skip forward to the *Setting Limits* section on the next page

CHANGING DOOR DIRECTION

To reverse the doors direction first put the unit into limit setting mode. To do this:

1. While holding STOP, press the SET button 3 times.
The *LIMIT ERROR* indicator will start flashing signifying limit setting mode.
2. Press and hold STOP for 10 seconds until the LIMIT ERROR indicator flashes quickly.

The direction of the doors movement will now be reversed.

The LIMIT ERROR indicator will remain flashing as the unit is still in limit setting mode. You can now set limits (go to step 1 on next page)

Or to exit, press STOP.

When the door direction is changed any set limits will be erased. Please re-set limit positions after changing door direction.

SETTING LIMITS

While holding STOP, press the SET button 3 times.

The LIMIT ERROR indicator will start flashing signifying limit setting mode.

1. Position door into the desired CLOSED position. *The manual hand chain can be used to accurately position the door before pressing set.*

IMPORTANT NOTE: Limits should only be set if you are sure mains power will remain on. Interruption to mains power exceeding 24hours (e.g. during construction) may cause limit loss.

2. Press the SET button to save this as the CLOSED position.
The LIMIT ERROR indicator will flash quickly then return flashing slowly.
3. Position door into the desired OPENED position.
4. Press SET again to save this as the OPEN position.
The LIMIT ERROR indicator will flash quickly then will go out.

The Closed and Open limits have now been set. If at anytime you need to exit limit setting mode, just press the STOP button.

Once set, run the door between limits a few times to check they are suitable

IMPORTANT – Fit any tags and labels provided to isolating switches and/or circuit breakers to prevent power from being shut off for extended periods. Limits will be lost if the Maestro is powered down for over 24 hours.

REMINDER - Limit setting should only be done when the mains power is finalised and will not be shut off for extended periods.

Standard installation of the Maestro Industrial Operator is now complete

Please refer to page 9 for further installation instructions of optional Maestro products

Operation

Now that the unit is installed and limits are set, it is ready to be operated

TO OPEN DOOR

Press and release the UP button on the front panel board

In default mode the door will rise upwards until it reaches the set upper limit or the STOP button is pressed. When travelling upwards you are not required to hold the UP button. Please refer to *Door Behaviour* on the next page for details

TO CLOSE DOOR

Press and hold the DOWN button on the front panel board

In default motion mode the door will move downwards until it reaches the set lower limit or until you release the DOWN button. When travelling downwards you are required to hold the DOWN button, unless the unit is fitted with a Photo-electric Beam and/or a Safety Edge System. Please refer to *Door Behaviour* on the next page for details

TO STOP DOOR IN MOTION

Press the STOP button on the front panel board

MANUAL OPERATION

The hand chain provided allows manual operation of the door at all times in which the motor is not in use. Use of the hand chain during powered operation of the door may result in damage to the equipment or injury to user. Ensure power is shut off before using manual chain.

Installation of Additional Features and Accessories (optional)

Door Behaviour and Obstruction Detection Inputs

The Maestro is capable of controlling the behaviour of the door in 3 distinct modes depending on its intended use and whether it is connected to an obstruction detection device.

Latch Up/Inch Down (Default) Mode:

The door will travel upwards with only a single press and release of the UP button. The door will stop at the next limit. This mode is latching upwards.

The door will only travel downwards when the DOWN button is held. The door will stop at the closed limit or when the button is released. This mode is inching downwards.

Inch Up and Down Mode:

The door will only travel whilst the UP or DOWN buttons are being held. The door will stop at the limits or when the button is released. To set this mode the INCH jumper must be fitted (ref. table below).

Latch Up and Down Mode:

The door will travel upwards and downwards with only a single press and release of the UP or DOWN button. The door will stop at the next limit or when the STOP button is pressed. To set this mode either the PLAT or BLAT jumper must be fitted (ref. table below). **This mode is only used in conjunction with an Obstruction Detection Device such as a PE beam or a Safety Edge system. Failure to do so may result in damage to property or injury to persons.**

SETTING DOOR BEHAVIOUR

To set the Door Behaviour modes, jumpers are placed over the door behaviour pins located on the corner of the MCB as shown over the page. The different combinations of jumpers suit different behaviours and obstruction detection devices installed.

Desired Behaviour	PE beam Installed	Bump Strip Installed	PE	PLAT	BLAT	INCH
Latch Up	N	N	OFF	OFF	OFF	OFF
Inch Down	Y	N	ON	OFF	OFF	OFF
Default	N	Y	OFF	OFF	OFF	OFF
	Y	Y	ON	OFF	OFF	OFF
*Latch Up Latch Down	Y	N	ON	ON	OFF	OFF
	N	Y	OFF	OFF	ON	OFF
	Y	Y	ON	ON	ON	OFF
Inch Up Inch Down	N	N	OFF	OFF	OFF	ON
	Y	N	ON	OFF	OFF	ON
	N	Y	OFF	OFF	OFF	ON
	Y	Y	ON	OFF	OFF	ON

ON: Jumper fitted

OFF: Jumper not fitted

* Must be set to latch up and down if Grifco Elite Expansion Board is being used

INSTALLING OBSTRUCTION DETECTION DEVICES

Devices such as PE beams and Safety Edge bumper strip systems allow safe automatic closing of the door and can be wired directly into the MCB via the appropriate cable entry. The devices are wired into the obstruction Inputs located next to the behaviour pins on the MCB (refer below).

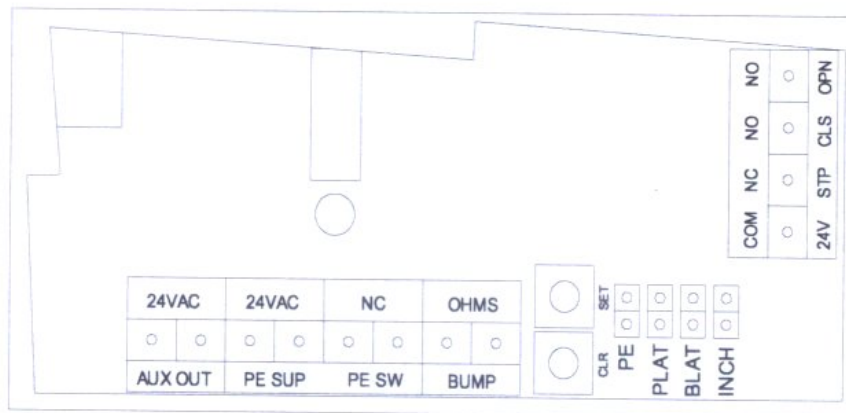

- PE SUP: Supply power for PE beam (24VAC)
 PE SW: Switch input from PE (Normally closed)
 BUMP: Bumper strip input (Ohms)

PE Beams (Part No. PE009), **Door Behaviour Jumpers** (Part No. JU10), and **Terminal Blocks** (Part No. TB2) are all available from your local industrial door dealer or Grifco.

OPTIONAL THIRD LIMIT

The Third Limit is a handy option especially for high doors that rarely need to be fully opened. The third limit is a door position **above** the Open limit position which can be accessed when needed. Having this upper position means that the open position does not have to be set fully open, but if the situation should occur that the door needs to be fully opened, it can be done so trouble free.

SETTING THE THIRD LIMIT

Once the Open and Closed limits have been set:

1. Position the door at the open limit position
2. Press and release the SET button 3 times within 3 seconds.
The LIMIT ERROR indicator will flash.
3. Now open the door further until the door is in the desired extended open position.
4. Press SET to save this as the extended open position.
The LIMIT ERROR indicator will quickly flash then go out.

The Extended Open limit has now been set.

TO OPEN DOOR TO THE EXTENDED OPEN LIMIT (optional)

Open the door to the OPEN limit. Once in the open limit press the UP button again to open the door to the extended open position.

Main Controller Board (MCB)

The MCB is the heart of the Maestro. It controls the behaviour of the motor. The diagram below provides an overview of the major components and access points.

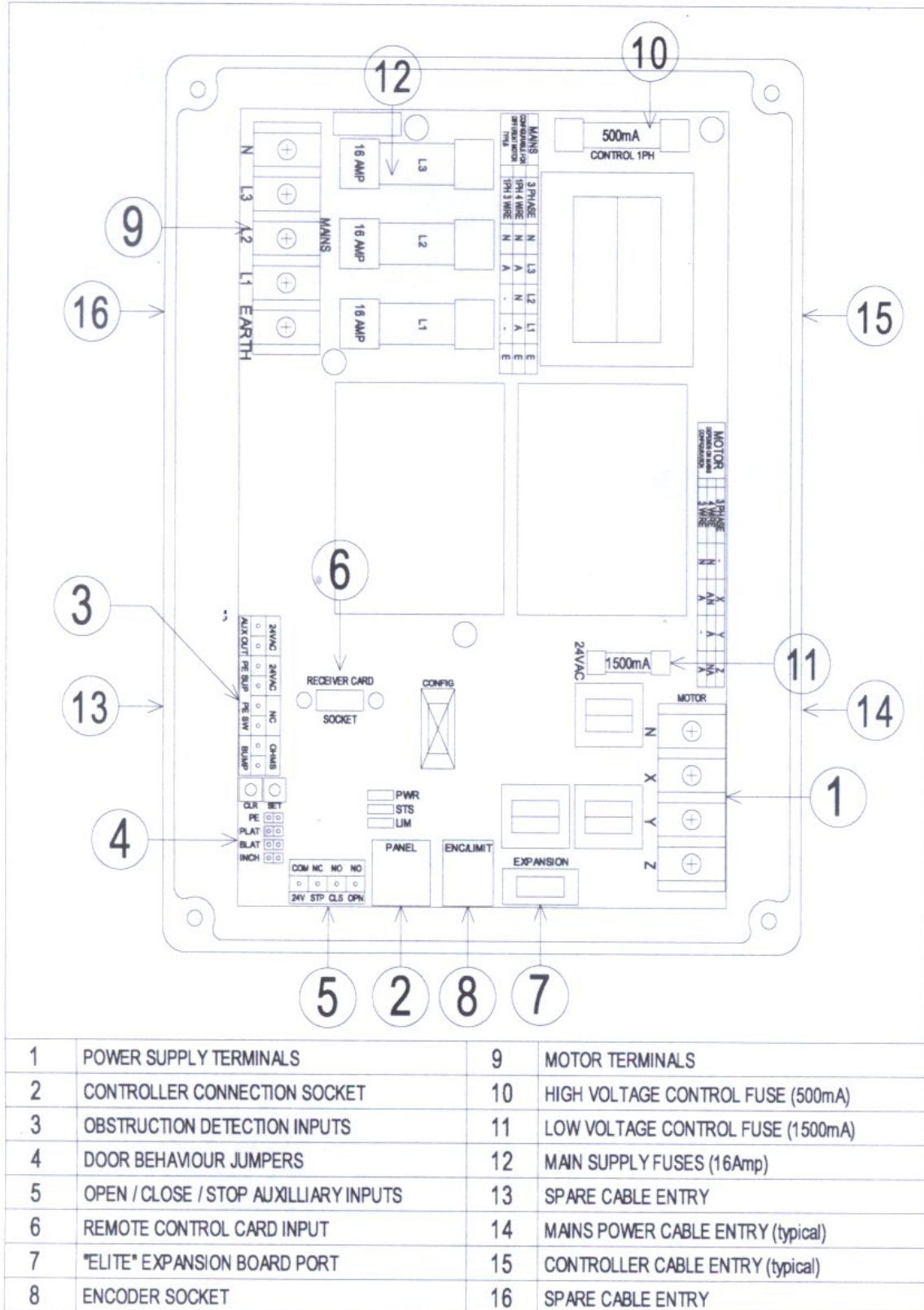

ACCESSORIES

Remote Control Card and Transmitter (optional)

Create a wireless link between you and your Maestro with Grifco's own Remote Card and Transmitter. With the remote card and transmitter you can operate the Maestro from a distance of up to 50m away.

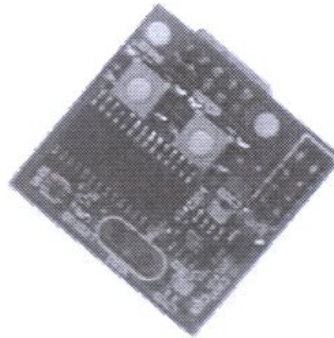

Features:

- Virgin card technology
- Wireless programming
- High security encoding

The Grifco Remote Card and Transmitter kit is available from your local industrial door dealer or Grifco (Part No. GTRK):

Other Controller Options

If required, Grifco has a range of "plug in" Controller options to add secure functions and features to your Maestro (see below).

<p>A built in isolating key allows push button panel to be isolated by the key holder.</p>	<p>The control above requires the key holder only to operate the door</p>	<p>The key holder only can operate this controller. The key type is "lockwood"</p>
<p>Model: C21B</p>	<p>Model: C21C</p>	<p>Model: C22C</p>

These and many other Controller options are available your local industrial door dealer or Grifco.

ACCESSORIES (continued)

Mini Expansion Board (MinEB)

The MinEB is a low cost plug in solution to provide an array of features such as:

- 24VDC to open or close
- dock leveller isolation signal
- door "closed" status
- ...and more

The Grifco **MinEB** is available from your local industrial door dealer or Grifco.

ELITE Expansion Board Upgrade Kit (optional)

This Grifco Expansion Board is a full featured addition to any *Maestro* operator, turning the standard *Maestro* into the *Maestro Elite*. This hardware adds more features to the unit, giving more options and more control.

Some features include:

- 4 relay outputs for controlling external devices
- Auto close with adjustable delay time
- Control over obstruction behaviour
- Programmable Trigger input
- Connection to a variety of radio cards
- Other inputs for advanced door behaviour

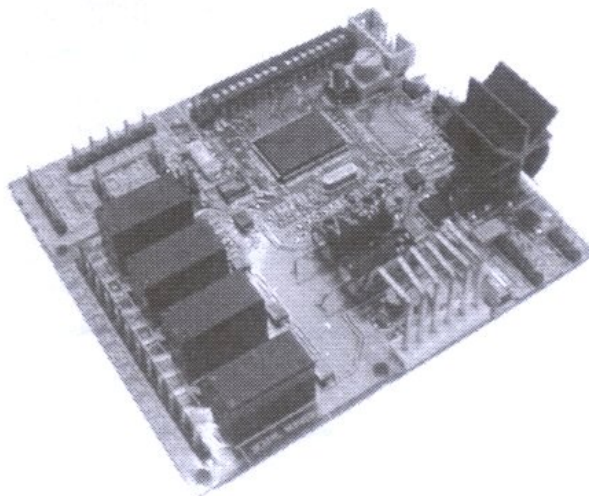

* The expansion board is the heart of the Elite upgrade

The most common version features a Controller with Auto / Man key switch, Weather proof polymer housing, 0-9metre photo electric beam, and Remote Control Kit. (Part No. E21E41)

The Grifco Expansion Board Upgrade Kit is available from your local industrial door dealer or Grifco.

Troubleshooting / Status indicator table

Status Indicator Flash Table

No. Flashes	Meaning	Possible causes	Possible Solutions
Solid ON	Motor running.		
1	Running on EB battery		
2	Photo beam and/or Bumper strip obstruction	PE beam broken Bumper strip pressed	<ul style="list-style-type: none"> • Check for obstruction • Double check installation of PE beam or bumper strip
3	Obstruction detection failure	Malfunctioning PE beam/Bumper strip	<ul style="list-style-type: none"> • Double check installation of PE beam or bumper strip
4	MCB internal error	Internal Error	<ul style="list-style-type: none"> • Power down, and up or Replace MCB (contact your local dealer or Grifco)
5	EB internal error	Fatal Error	<ul style="list-style-type: none"> • Replace EB (contact your local dealer or Grifco)
6	Maximum starts per hour reached	Operator used above maximum rated starts per hour	<ul style="list-style-type: none"> • Use operator less frequently • Upgrade to a high cycle or larger operator
7	Max run time reached	Operator used above maximum rated running time	<ul style="list-style-type: none"> • Use operator less frequently • Upgrade to a high cycle or larger operator
8	Current Imbalance	Phase missing (only applicable to 3 phase operators)	<ul style="list-style-type: none"> • Check mains wiring • Check fuses • Check motor
9	Locked Rotor overload	Excess load on door Door or motor stalled	<ul style="list-style-type: none"> • Check for objects causing interference to door operation • Check for damage to motor • Upgrade to a larger motor or operator
10	Severe Running overload	Extreme load on door	<ul style="list-style-type: none"> • Check for objects causing interference to door operation • Check for damage to motor • Upgrade to a larger motor or operator
11	Running overload	Excess load on door	<ul style="list-style-type: none"> • Check for objects causing interference to door operation • Check for damage to motor • Upgrade to a larger motor or operator • Increase overload setting
12	Thermal overload	Motor overheating	<ul style="list-style-type: none"> • Check thermal overload wiring • Use operator less frequently • Upgrade to a high cycle or larger operator
13	Travel Time High	Motor running under speed Excess load on door Optical limits damaged	<ul style="list-style-type: none"> • Check door for mechanical failure • Open OE enclosure and check for damage or excess dust
14	Direction Error	Motor rewired incorrectly Optical Limits damaged	<ul style="list-style-type: none"> • Change door direction and/or reset limits • Open OE enclosure and check for damage or excess dust
15	Under speed	Motor running under speed Excess load on door Optical limits damaged	<ul style="list-style-type: none"> • Check door for mechanical failure • Open OE enclosure and check for damage or excess dust
Constant	Due for service	Door is due for routine service	<ul style="list-style-type: none"> • Contact your local door dealer to arrange service
No Lights Displayed	Power Failure	Blown fuse Power supply not correctly connected	<ul style="list-style-type: none"> • Check all fuses • Check power supply wiring

Maintenance

The Maestro is equipped with smart logic to indicate when your industrial door will require servicing.

When the STATUS indicator constantly flashes quickly, please contact your industrial door dealer to arrange a routine door service.

Overload Adjustment

This process is not generally necessary for typical applications. Varying overload levels significantly from the Factory Set level may void warranty.

To view full load current (FLC) overload setting

- Limits must be set
- Drive door to closed limit position
- Press and hold close and stop buttons together for 10 seconds
- Status LED will light up indicating number of cycles
- *To read full load current, perform the '**Reading Status Flashes**' routine described below

To view max amps

- Limits must be set
- Drive door to closed limit position
- Press and hold CLOSE button for 10 seconds
- After 10 seconds and while still holding CLOSE, press and release the STOP button
- Status LED will light up indicating maximum amps drawn
- *To read max amps, perform the '**Reading Status Flashes**' routine described below

To change full load current (FLC) overload setting

- While holding STOP, press the SET button 3 times
- The LIMIT ERROR indicator will start flashing signifying limit setting mode
- Press and hold the STOP button
- While holding STOP, press either UP or DOWN to increase or decrease the FLC by 0.1A with each press
- The LIMIT ERROR indicator will flash with every successful increment/decrement
- *To read max amps, perform the '**Reading Status Flashes**' routine described below
- The FLC can be modified a maximum of 1.5A per session
- Once done release the STOP button, then press the STOP button again to exit

*Reading Status Flashes

- STATUS indicator will start flashing to signify to value of the least significant digit of the overall number, or in the case of amperage values this will be the value after the decimal point. A solidly lit indicator stands for zero
- Press set to view the next digit
- Continue previous step until the STATUS indicator flashes quickly for 1 sec then goes out. This signifies that the entire number has been displayed

WARRANTY / GUARANTEE

- (a) The Company shall guarantee the goods for a period of two years from the date of invoice against any defects in construction or operation arising solely from faulty design, materials or workmanship.
- (b) The Company shall at its option repair, modify or replace defective parts or units at its own expense and within a reasonable time but the Company shall not unless otherwise agreed in writing be liable for any transport or travelling expenses incurred by the Purchaser in obtaining the goods and returning them to the Company.
- (c) The Company does not guarantee the goods where:-
- (i) the defect rises from materials supplied by the Purchaser or a design requested by the purchaser; or
 - (ii) the defect arises from ordinary wear and tear, neglect or misuse by the Purchaser, accident, lack of care, insufficient maintenance, incorrect installation or improper use of the goods; or
 - (iii) the defect arises from force majeure; or
 - (iv) the Purchaser has in any way modified or repaired the goods without the Company's prior written consent; or
 - (v) the Purchaser has not complied with any written or oral instructions concerning the operation and maintenance of the goods; or
 - (vi) the Purchaser is in default in the observance or performance of any other provisions of the contract.
 - (vii) The Grifco electric motors are used in conjunction with controls other than those assembled and supplied by Charles H. Griffith & Co P/L.
- (d) To keep installation running, a covering purchase order can be placed with the company for the replacement goods. If returned goods are found to be defective by Charles H. Griffith & Co P/L, goods will then, not be charged to the customer.
- (e) The Company's liability under this guarantee will be strictly limited to repairing or replacing a defective product, as it may elect.
- (f) The provision of sub-clauses (a) and (b) are stipulated for the benefit of the Purchaser only and are not intended for the benefit of any third party.
- (f) Save for sub-clauses (a) and (b) the Company does not give any warranty or guarantee or make representations whatever in respect of the goods or the fitness of the goods or any part thereof or any particular purposes (whether or not that purpose is known to the Company).

Proudly made in Australia by:

Charles H Griffith & Co Pty Ltd

15 Dell Rd West Gosford
NSW 2250
Australia

Ph. +61 (02) 43233877

Fax. +61 (02) 43233882

www.grifco.com.au

sales@grifco.com.au

technical@grifco.com.au