



Controll-A-Door®

Smart SDO-7 & Secure SDO-6
Sectional Door Openers

Resetting the counter On Tempo ATS-2 and B&D SDO-6

These new openers will flash 6 times to indicate service.
They will reset automatically after 30 operations.
To reset prior press the SET/STOP button during the flashing

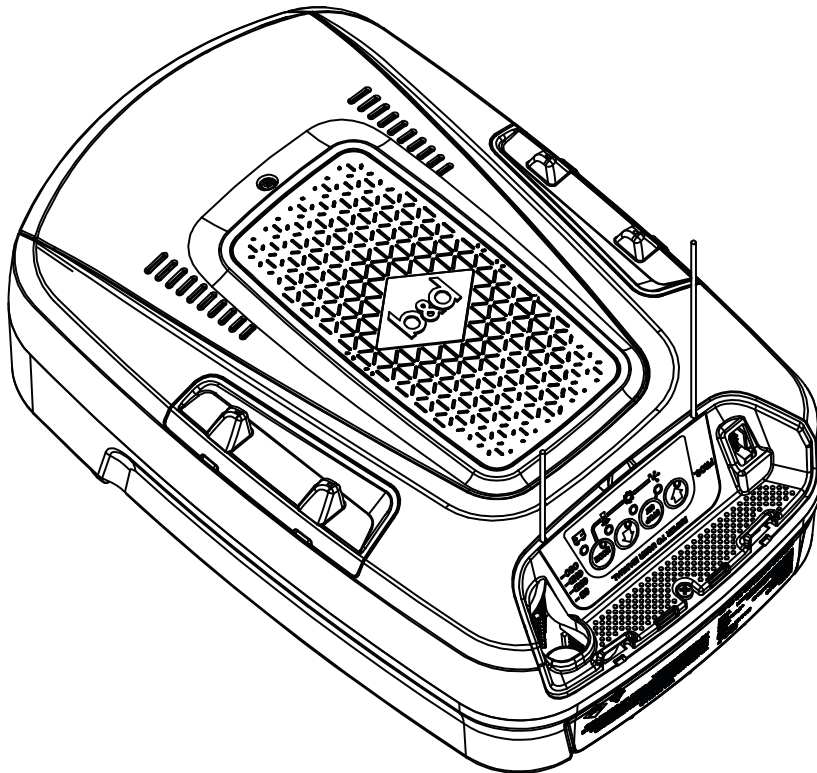

Contents

Installation Instructions

1. Installation Safety Warnings!	3
2. Before you Begin	4
3. Tools Required	4
4. Kit Contents	5
5. Position	5
6. Fit the Opener	6
7. Bracket Position	6
7.1 Wall Bracket Position:	6
7.2 Mounting the Wall Bracket:	6
7.3 Attach the Track to the Wall Bracket	6
8. Perforated Angle	7
9. Mounting Brackets and Arms	7
9.1 Mounting the Door Bracket:	7
9.2 Attaching the Arms	7
10. Optional Safety Beam Kit	8
11. Specifications	8
12. Setting Limits	9
12.1 Set the Limit Positions / adjust drive speed:	9
12.2 Clearing the Door Limit Positions	9
12.3 Re-profiling the Door	9
13. Safety Testing	10
13.1 Test the Close Cycle	10
13.2 Testing the Open Cycle	10
13.3 Test the Manual Door Operation	10
14. Auto-Close	11
15. Coding a Transmitter	12
15.1 Storing the Transmitter Code	12
15.2 Installation of the Wall Mounted Transmitter	12
15.5 Remotely Coding Transmitters	12
15.3 Erasing All Transmitter Codes	12
15.4 Vacation Mode	12
16. Smart Phone Control (SDO-7 only)	13

Home Owner Instructions

17. Home Owner Safety Warnings!	14
18. Opener Safety & Security	15
18.1 Your Door CAN NOT be used:	15
18.2 Your Door CAN be used when:	15
18.3 To Disengage the Opener:	15
18.4 To Re-Engage the Opener:	15
19. Operating your Opener	15
20. User Operating Controls	16
21. Maintenance	17
21.1 Door Maintenance	17
21.2 Battery Replacement	17
21.3 Battery Disposal	17
22. Troubleshooting	18
23. Appendix	20
A - Status Indication during Operating Mode	20
B - Adjustment Mode Instructions	21
C - Adjusting Force Margins	21
D - Battery Functions	21
E - Setting Limits via Transmitter	22
F - Setting the PET mode position	22
G - Setting up Tilt Door	23
24. Warranty	24

1. Installation Safety Warnings!

This automatic garage door opener is designed and tested to offer safe service provided it is installed and operated in strict accordance with the following safety warnings. Failure to comply with the following instructions may result in death, serious personal injury or property damage.



WARNING!

- The door may operate unexpectedly, therefore do not allow anything to stay in the path of the door.
- When operating the manual release while the door is open, the door may fall rapidly due to weak or broken springs, or due to being improperly balanced.
- The drive must not be used with a door incorporating a wicket door, unless the drive cannot be operated with the wicket door open.
- The drive is intended to be installed at least 2.5m above the floor.
- Do not disengage the opener to manual operation with children/persons or any objects including motor vehicles within the doorway.
- If the door is closing and is unable to re-open when obstructed, discontinue use. Do not use a door with faulty obstruction sensing
- When using auto close mode, a Photo Electric beam must be fitted correctly and tested for operation at regular intervals. Extreme caution is recommended when using auto close mode. All safety rules must be followed.
- Place opener in protected area so that it does not get wet.
- Do not spray with water .
- Disconnect the power cord from mains power before making any repairs or removing covers. Only experienced service personnel should remove covers from the opener.
- If the power supply cord is damaged, it must be replaced by an Automatic Technology service agent or suitably qualified person.
- Connect the opener to a properly earthed general purpose 240V mains power outlet installed by a qualified electrical contractor.



ELECTROCUTION!

- If garage has no pedestrian entrance door, an emergency access device should be installed. This accessory allows manual operation of the garage door from outside in case of power failure.
- Practice correct lifting techniques (carton weighs approx 9kgs)
- Practice correct lifting techniques when required to lift the door as per installation instructions.
- Ensure ladder is the correct type for job.
- Ensure ladder is on flat firm ground that will take the weight without the legs sinking.
- Ensure user has 3 points of contact while on ladder.
- Place a 2 metre exclusion zone around area under the door while it is unsecured.
- Follow the installation instructions
- Examine the door installation, in particular, springs and mountings for signs of wear, damage and imbalance.
- The garage door must be well balanced. Sticking or binding doors must be repaired by a qualified garage door installer prior to installation of the opener.
- Remove or disengage all garage door locks and mechanisms prior to installation of the opener.
- Never plug in and operate opener prior to installation.
- Keep hands and loose clothing clear of door and guides at all times.
- DO NOT operate the opener unless the garage door is in full view and free from objects such as cars and children/people. Make sure that the door has finished moving before entering or leaving the garage
- In order for the opener to sense an object obstructing the door way, some force must be exerted on the object. As a result the object, door and/or person may suffer minor damage or injury.
- Ensure the garage door is in good working order by undertaking regular servicing.
- Install the optional wall transmitter in a location where the garage door is visible, but out of the reach of children at a height of at least 1.5m.
- Photo Electric beams must be installed if the closing force at the bottom edge of the door exceeds 400N (40kg)



CAUTION:

Emergency Access

Muscular strain

Fall from ladder

Crush injury from unsecured door

Garage Door

Entanglement

Entrapment under operating door

- If garage has no pedestrian entrance door, an emergency access device should be installed. This accessory allows manual operation of the garage door from outside in case of power failure.
- Practice correct lifting techniques (carton weighs approx 9kgs)
- Practice correct lifting techniques when required to lift the door as per installation instructions.
- Ensure ladder is the correct type for job.
- Ensure ladder is on flat firm ground that will take the weight without the legs sinking.
- Ensure user has 3 points of contact while on ladder.
- Place a 2 metre exclusion zone around area under the door while it is unsecured.
- Follow the installation instructions
- Examine the door installation, in particular, springs and mountings for signs of wear, damage and imbalance.
- The garage door must be well balanced. Sticking or binding doors must be repaired by a qualified garage door installer prior to installation of the opener.
- Remove or disengage all garage door locks and mechanisms prior to installation of the opener.
- Never plug in and operate opener prior to installation.
- Keep hands and loose clothing clear of door and guides at all times.
- DO NOT operate the opener unless the garage door is in full view and free from objects such as cars and children/people. Make sure that the door has finished moving before entering or leaving the garage
- In order for the opener to sense an object obstructing the door way, some force must be exerted on the object. As a result the object, door and/or person may suffer minor damage or injury.
- Ensure the garage door is in good working order by undertaking regular servicing.
- Install the optional wall transmitter in a location where the garage door is visible, but out of the reach of children at a height of at least 1.5m.
- Photo Electric beams must be installed if the closing force at the bottom edge of the door exceeds 400N (40kg)



2. Before you Begin

2.1 Examine the conditions in the garage:

a. Look at the ceiling:

- i. Is it plastered? The opener is mounted to a perforated angle which **MUST** be securely fastened to a structural support. You will need to locate the structural beams in the ceiling which are generally 400mm apart.
- ii. does it have exposed beams? The opener is mounted to a perforated angle which must be securely fastened to a structural support like the exposed beams. You may need to install a 40mm thick board (not supplied) between structural supports.

b. Look at the wall above the garage door.

- i. Is it brick? The wall bracket **MUST** be securely fastened to the wall with suitable screws and ensure it does not move.
- ii. Is it timber? The wall bracket **MUST** be securely fastened to a structural support. You may need to install a 40mm thick board (not supplied) between structural supports to fasten the wall bracket to.

2.2 Test the following before commencing installation:

- a. The door **MUST BE** in good operating condition.
- b. Manually move the door up and down, the door should move freely without binding or sticking. When the door is fully closed it should raise itself by 10cm off the floor. Retension door if necessary.
- c. The maximum force required to move the door should not exceed 20kg.
- d. Lift the door to about halfway. When released, the door should stay in place.

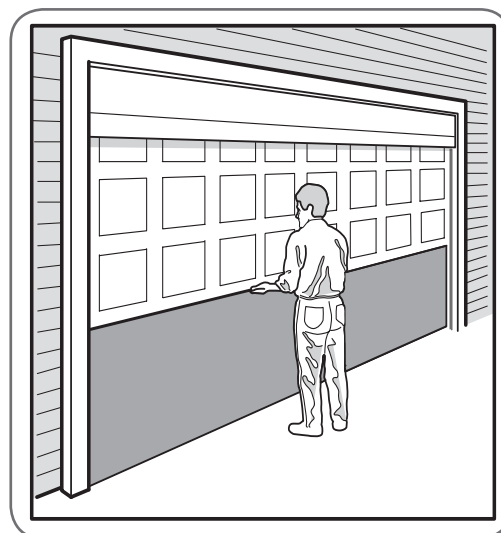

DO NOT DO IT YOURSELF:

If any of the above door requirements are not met, **DO NOT** attempt to fix yourself. Please contact a garage door professional. (P) 13 62 63

3. Tools Required

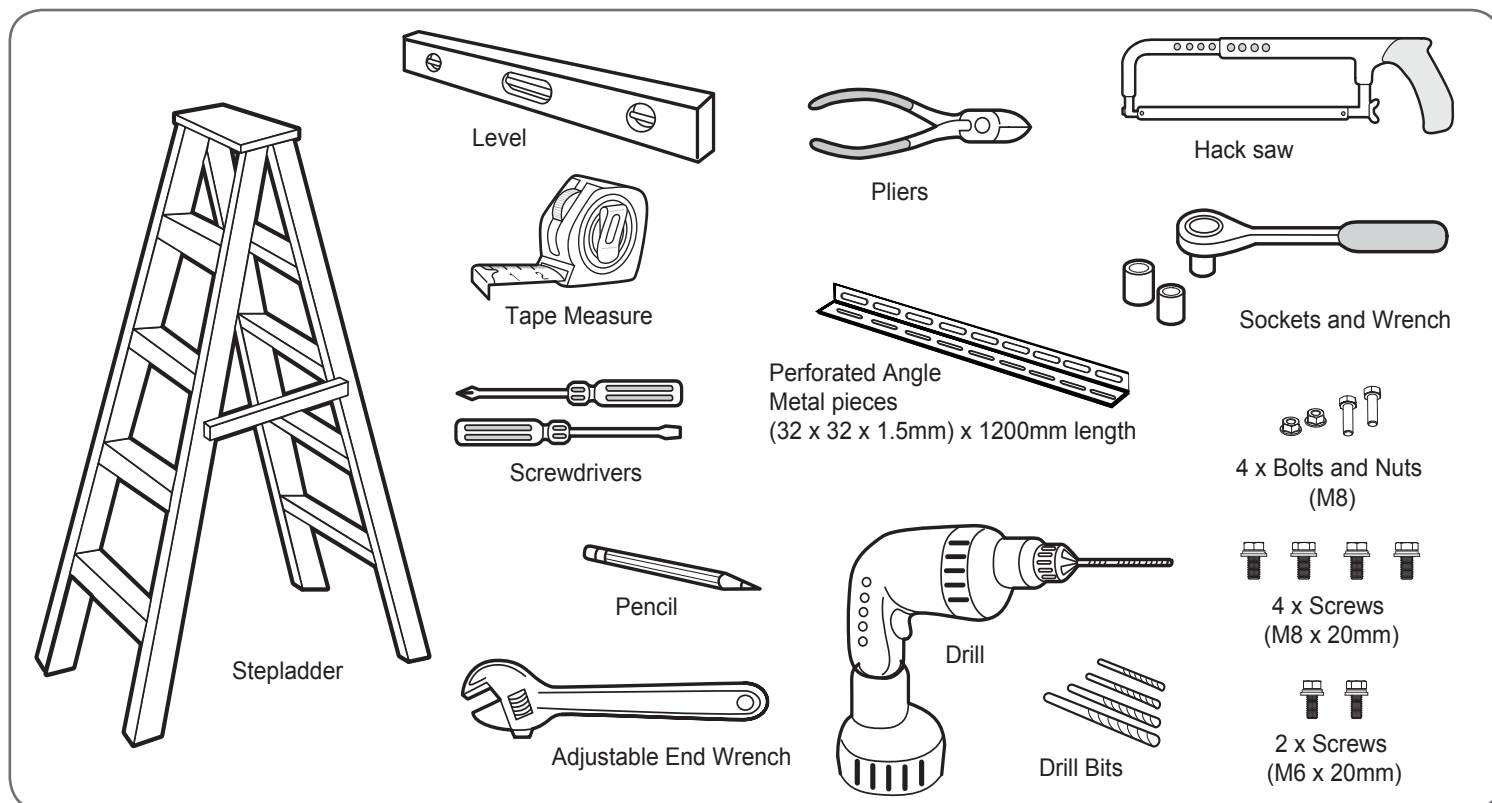

4. Kit Contents

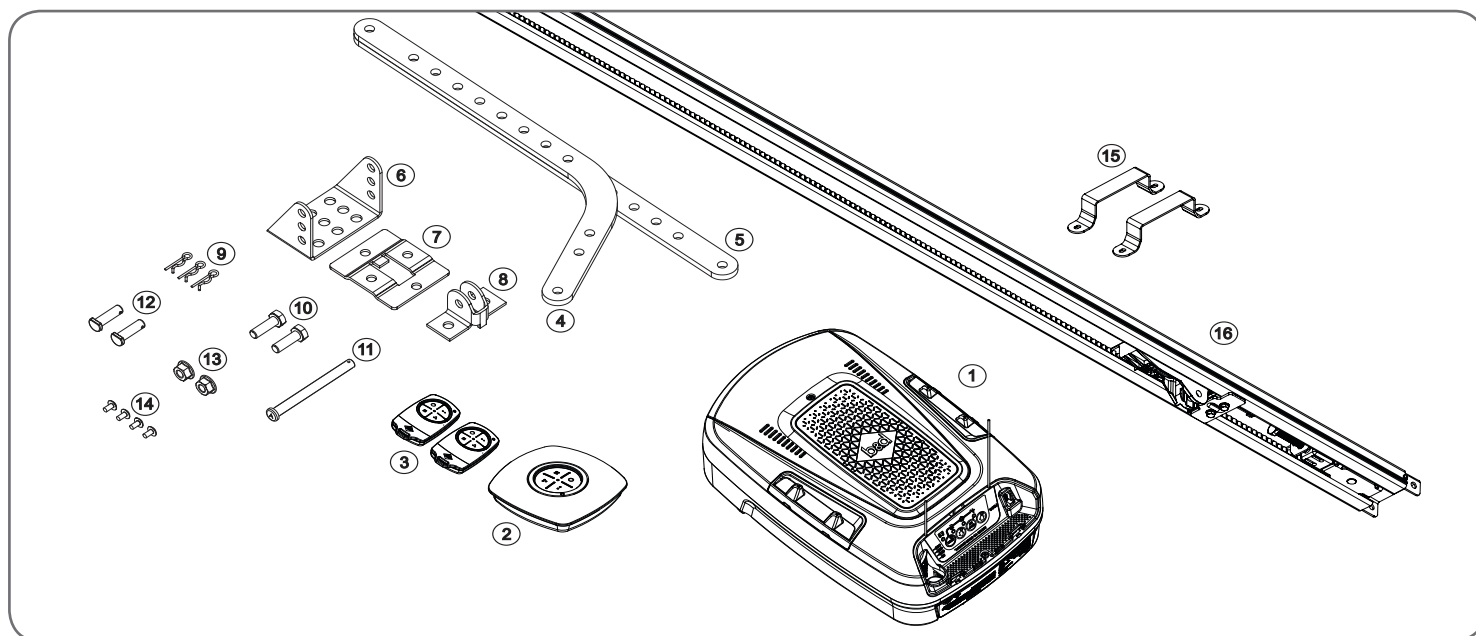

- | | | | | | |
|----|----------------------------------|-----|----------------------------------|------|-------------------------|
| 1. | 1 x SDO drive unit | 8. | 1 x Door bracket | PLUS | |
| 2. | 1 x Wall mount transmitter | 9. | 3 x Pin Snap SSP 8 ZNU 31080 | 15. | 2 x Track Bracket |
| 3. | 2 x Transmitters | 10. | 2 x Hex Head screw M8x25 | 16. | 1 x Pre-Assembled track |
| 4. | 1 x Bent arm door attachment | 11. | 1 x Pin 0890 | | |
| 5. | 1 x Straight arm door attachment | 12. | 2 x Clevis Pin 0829 | | |
| 6. | 1 x Wall bracket TS01 | 13. | 2 x Hex Serration flange nut M8 | | |
| 7. | 1 x Door bracket Locator | 14. | 4 x Hex flange screw 'S' M4 x 10 | | |

5. Position

The Opener:

- MUST BE installed in a dry position, protected from weather.
- REQUIRES properly earthed 3 pin single phase power on the ceiling within an arms length of the opener.
- Requires a MINIMUM HEADROOM of 57mm between the highest point of the door's travel and the ceiling.
- Use the diagram below as a reference when completing the installation.

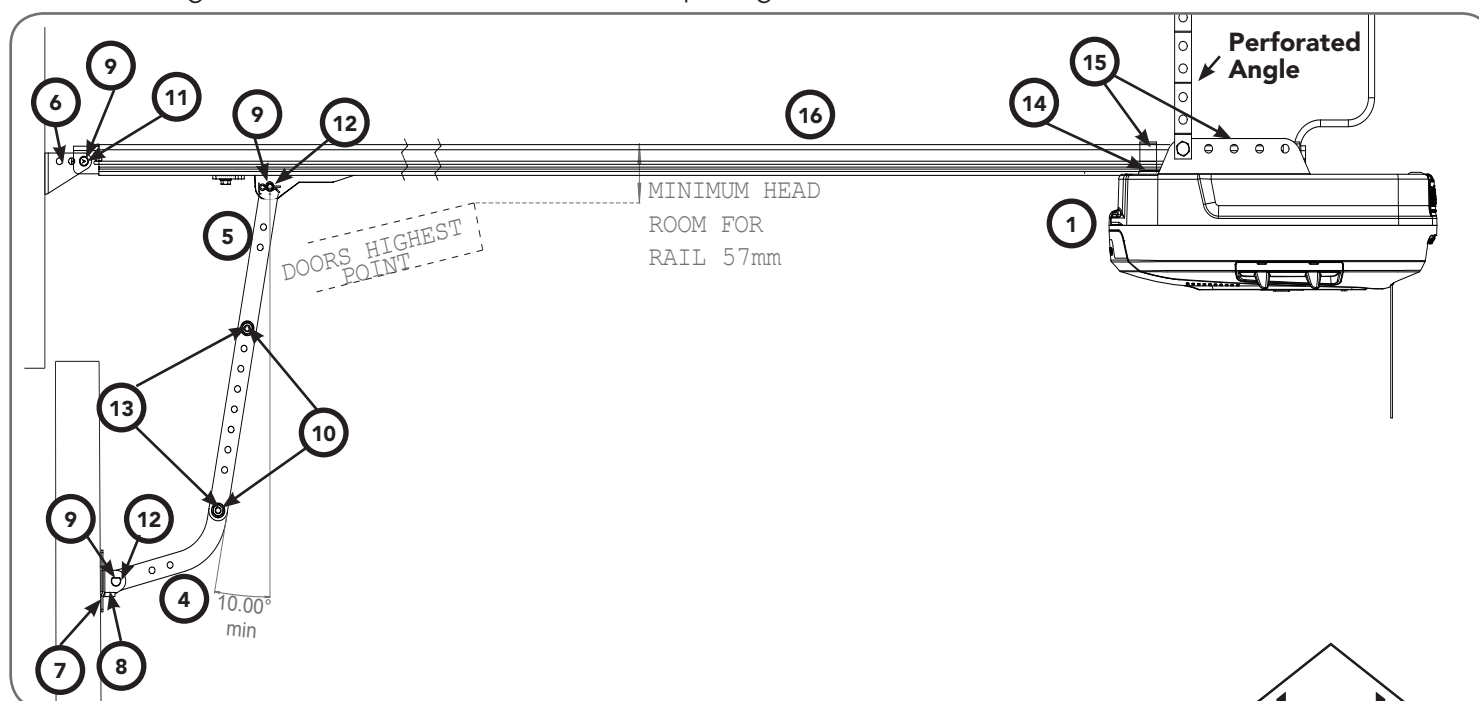

6. Fit the Opener

6.1 Secure C-Rail to Opener:

- Remove the Opener from the box, taking care of antenna (if fitted).
- Locate and insert the shaft of drive unit (1) into the C-Rail's sprocket.
- Fix the two track brackets (15) with four (4) M4 x 8 screws (14) supplied in accessory pack.
- Place drive unit back in packing box for protection.

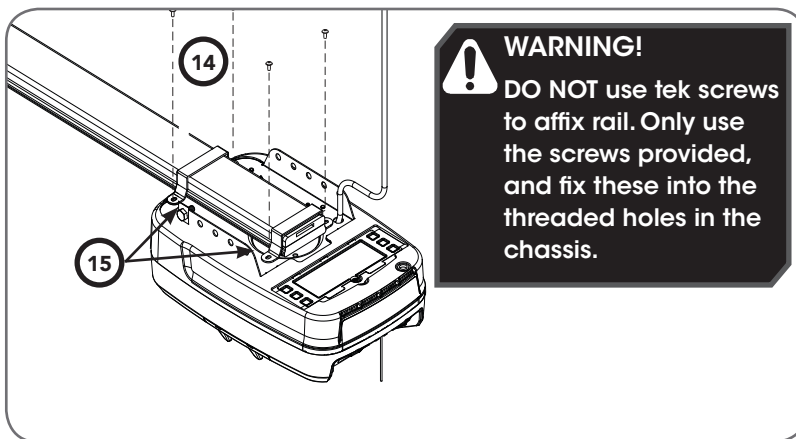
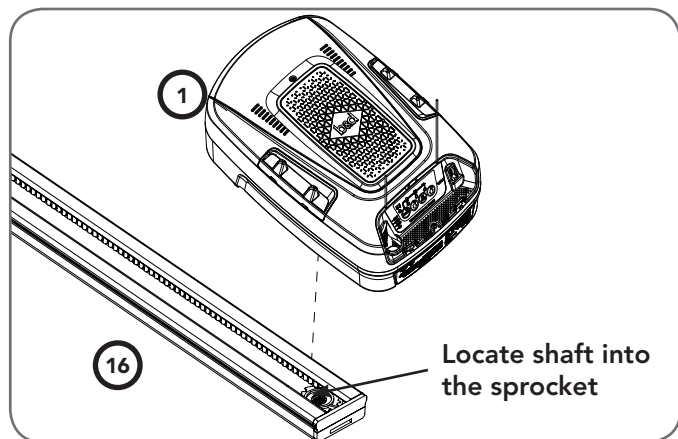

7. Bracket Position

7.1 Wall Bracket Position:

- Determine the centre of the door and mark this point with a line on the wall above.
- Raise the door and find the highest point of travel of the first (top) door panel.



WARNING! The Opener must be securely fastened to structural supports, otherwise opener failure may ensue causing serious personal injury and / or property damage.

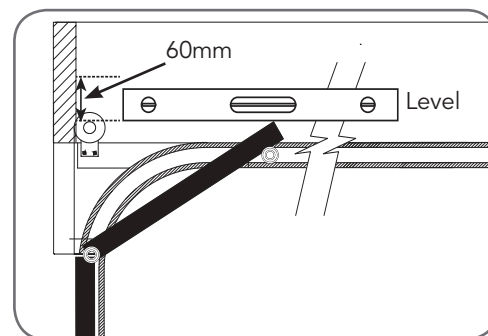

- Using step ladder and a level, transfer this height to the wall above the door and mark a line 60mm above it, across the centre line.



DO NOT DO IT YOURSELF: If sufficient structural support can not be found, contact a door professional for installation.

7.2 Mounting the Wall Bracket:

- Draw two lines extending 21.5mm from each side of the centre point.
- Centre the wall bracket (6) over the intersection of these two lines. Mark centres for at least two holes and ensure it is into a solid mounting point.
- Drill holes in the wall with an appropriate bit.
- Secure to the wall using:
 - IF CONCRETE OR BRICK:
8mm (5/6") loxins/dynabolts.
 - IF TIMBER:
wood screw #20 or similar (min. 50mm).

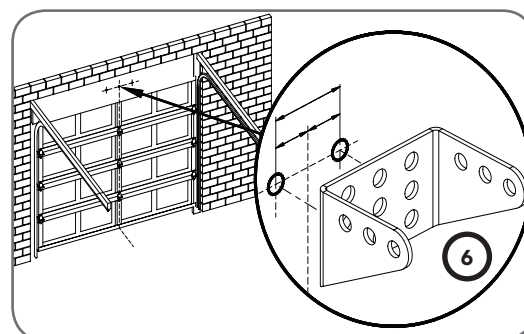

7.3 Attach the Track to the Wall Bracket

- Leave the drive unit in its packing box on the floor for protection and lift the other end of the C-Rail.
- Attach the pre-assembled track (16) to the wall bracket (6) with the 90mm long pin (11) and secure with the supplied pin snap (9).

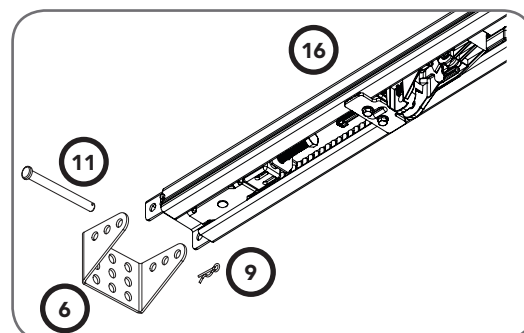

tip Keep the Tracklock manual on hand as after setting limits in Section 11, refer to the tracklock manual to set the tracklock and tension the track.

8. Perforated Angle (Not supplied)

8.1 Attach Perforated Angle or equivalent

- Measure across the ceiling from the centre point 3177mm (+/- 150mm) to find a supporting beam.
- Create a perforated angle which best suits your site. Use a hack saw to cut the L shape metal strips. Secure the perforated angle to a supporting beam using diagrams shown below.
- Raise the drive unit to the ceiling mounted perforated angle and secure with M8x20mm screws and nuts (not supplied). Strips should not extend more than 18mm below centre of drive unit mounting holes.
- To prevent moisture on the C-rail running into the powerhead it is recommended a strip of silicon sealant is placed across the top of the C-rail just before the opener.

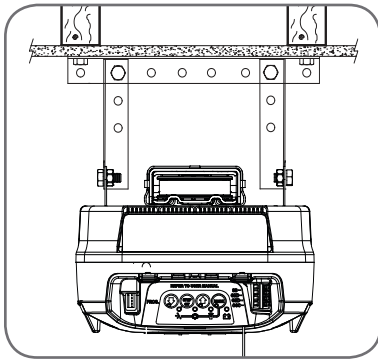

Ceiling Beams that run towards the door requires:
 1 x perforated L shape metal strip and
 2 x shorter perforate L shape metal drop down strips..

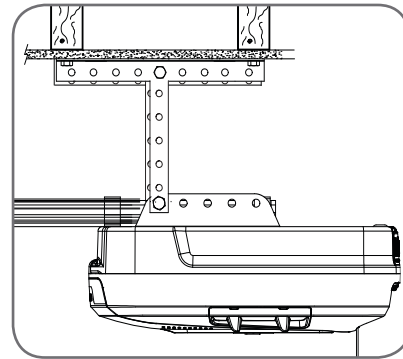

Ceiling Beams that run parallel to the door requires:
 2 x perforated L shape metal strips and
 2 x shorter perforate L shape metal drop down strips..

9. Mounting Brackets and Arms

9.1 Mounting the Door Bracket:

- The door bracket locator (7) is placed over the door bracket (8), on the door's centre line one-third down the top panel and mounted using M6 or equivalent screws (not supplied).
- STEEL DOORS ONLY:** Bracket can be welded in place.

NOTE: If in doubt about the door's strength, reinforcement may be added to the door's frame where necessary. Door damage may occur if the bracket is installed on a panel with insufficient strength. The opener's warranty does not cover damage caused to the door and/or door panels.

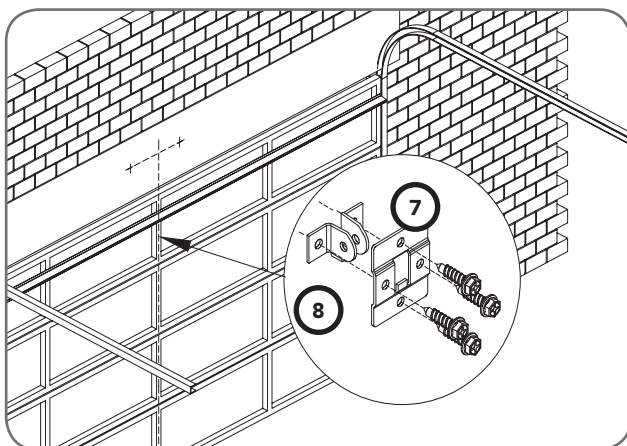

9.2 Attaching the Arms

- Assemble the bent arm (4) (connecting to the door) to the right side of the straight arm (5) with bolts (10) and nuts (13) supplied in the accessory pack. Connect the straight arm (5) to the shuttle with a clevis pin (12) and a pin snap (9). Always use both bent and straight arms.
- Connect the assembled arm to the bracket with clevis pin (12) and pin snap (9).
 The angle "A" must be more than 10°.

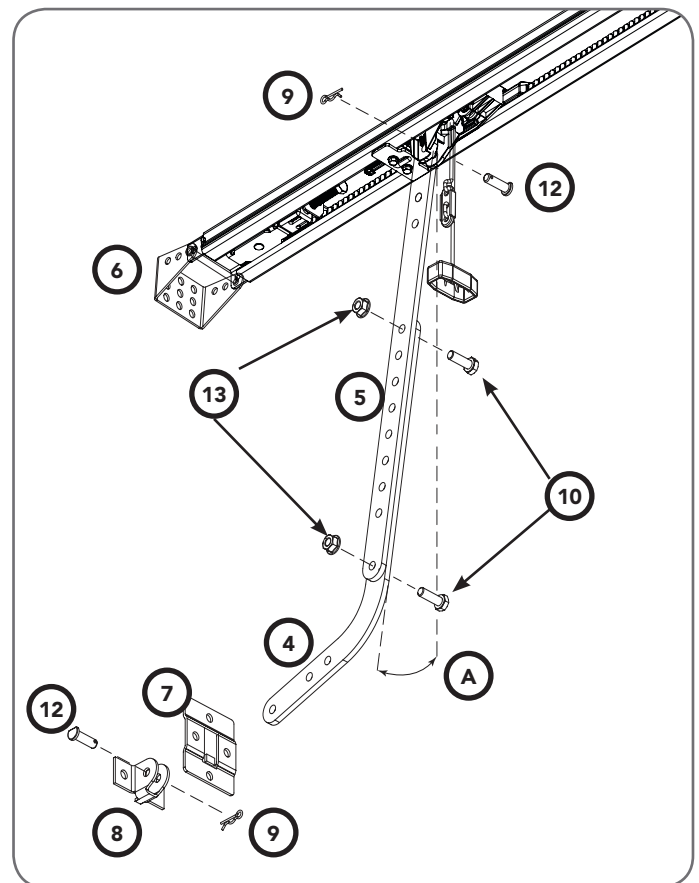

10. Optional Safety Beam Kit

10.1 Safety Beams

The Safety Beam Kit provides additional safety by preventing the door closing when the beam is blocked by a car, child etc. When the Safety Beam Kit is installed the Auto-close feature can be enabled if required.

- a. To install the Safety Beam Kit, refer to the Safety Beam instruction supplied with the kit.
- b. After the beams are installed the beam alignment feature of the opener can be used.
- c. Turn power on to the opener.
- d. Align the safety beams using the main light as a guide:
 - i. bright = aligned
 - ii. dull = not aligned or blocked

When the beam is aligned or if no beam is fitted, continue with Setting Limits.

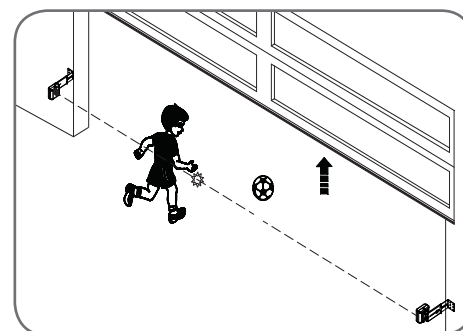

11. Specifications

Technical Specifications	Controll-A-Door® Smart SDO-7	Controll-A-Door® Secure SDO-6
Rated voltage range:	230V - 240Va.c.	230V - 240Va.c.
Rated frequency:	50Hz / 60Hz	50Hz / 60Hz
Rated power input:	165W	165W
Door opening: Maximum Door Area: Maximum Door Weight:	18m ² 236kg*	18m ² 236kg*
Door must be well balanced and able to be operated by hand, as per warranty conditions and AS/NZS 4505:2012		
Minimum headroom	57mm	57mm
Rated Operating Time	4 mins	4 mins
Rated Temp	+5°C to +40°C	+5°C to +40°C
Short Term Peak force:	1100N	1100N
Door travel speed (mm/sec)	180mm	180mm
Rated load	400N	400N
Nominal force	200N (20kg)	200N (20kg)
Receiver type	Multi-frequency UHF FM (433.47, 433.92 & 434.47MHz)	Multi-frequency UHF FM (433.47, 433.92 & 434.47MHz)
Receiver code storage capacity	64 X 4-button Transmitters	64 X 4-button Transmitters
Transmitter battery	CR2032 (3 Volts)	CR2032 (3 Volts)
Courtesy light	LED (Light Emitting Diodes)	LED (Light Emitting Diodes)
Network connectivity	Network ready (Smart hub already installed)	Requires optional (Smart Phone Control Kit)

* Gross door weight, including all fittings

Note: During the open and close cycles, intermittent operations may occur in areas which experience very strong winds. The strong wind puts extra pressure on the door and tracks which may in turn intermittently trigger the safety obstruction detection system.



12. Setting Limits

tip If a tracklock is being installed with the opener, make sure the tracklock plate is not secured in position until limits are set. Refer to tracklock manual.

12.1 Set the Limit Positions and adjust drive speed:



When setting the Close limit, ensure the position is when the door makes first contact with the ground. Alternatively for the Open limit the position should be at the height of the garage opening.

NOTE: The drive speed is set to the fastest setting by default. This may not be suitable for larger doors or for single piece doors. For tilt doors (J-Type only), please refer to Appendix G for initial setup.



a. Switch power on and the BLUE LED on the CLOSE button  will start to flash and the GEAR  LED is lit to indicate that the opener is ready to set the Close travel limit.

b. Press either the CLOSE  or OPEN button to move the door to the halfway point.

CLOSE limit:

- i. Press and hold the CLOSE button  to start closing the door, taking note of the speed the door moves.
- ii. If the close speed is not suitable, to make a change, press and hold the CLOSE button and by pressing the STOP / SET button on the opener it will cycle through all three speed modes as shown in table.
- iii. Once at the desired speed, release the CLOSE button.
- iv. To set the close limit, inch the door by making single presses of the CLOSE button  to the desired position. We recommend the CLOSE limit position being the first point of contact of the rubber strip (at the bottom of the door) with the ground.

WARNING! In setting the close limit position, do not force the door into the floor with excessive force, as this can interfere with the ease of operation of the manual release mechanism.

- v. If the door overshoots, press the OPEN button  to move the door in the OPEN direction.
- vi. When the door is at the desired CLOSE position, press the STOP / SET button on the opener, the GREEN LED on the OPEN button  will now flash.

NOTE: If unhappy with the speed or travel limit setting, restart this procedure by resetting the door limit positions as per below first.

12.2 Clearing the Door Limit Positions

Limit positions can be deleted by:

- a. Press the MODE button repetitively until the GEAR  LED is lit.
- b. Press and hold the MODE button for 10 secs, let the MODE button go when the main light stops flashing.
- c. The close LED will flash continuously to indicate limits have been cleared.

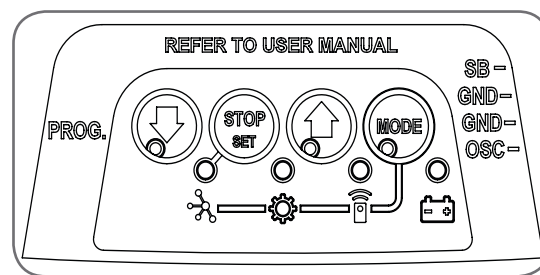

NOTE: If no action is taken within 30 seconds, the opener will return to normal operating mode and restore the original settings.

- d. Follow from CLOSE limit: above to set new limit positions, remembering to reset the tracklock.



Door Opener Speed Mode	STATUS	MAIN LIGHT
Fast (Default)	On	3 Flash
Medium	On	2 Flashes
Slow	On	1 Flashes

OPEN limit:

- i. Press and hold the OPEN button  to start opening the door, taking note of the speed the door moves.
- ii. If the open speed is not suitable, to make a change, press and hold the OPEN button and by pressing the STOP / SET button on the opener it will cycle through all three speed modes as shown in table.
- iii. Once at the desired speed, release the OPEN button.
- iv. Continue inching the door to the desired position.
- v. To set the open limit, inch the door by making single presses of the OPEN button  to the desired position. We recommend the OPEN limit position being the height of the garage opening.



WARNING! The door will automatically close, open and close again after the next step. Ensure that nothing is in the door's path.

- vi. If the door overshoots, press the CLOSE button  to move the door in the CLOSE direction.
- vii. When the door is at the desired OPEN position, press the STOP / SET button. The door will now automatically close and open to calculate the safety obstruction settings.

tip Once limits are set, refer to the tracklock manual to set the tracklock and check the tension of the track.

12.3 Re-profiling the Door

Re-profiling is a simplified way of re-learning the travel characteristic of a previously setup Limit Switch travel installation. Re-profiling can be used when the travel characteristics of the door change due to mechanical adjustments etc. To initiate a re-profile:

- a. Limits must be set.
- b. Press the MODE button repetitively until the GEAR  LED is lit.
- c. Press and hold the CLOSE button  for two seconds, the door will open and close by itself to record profile.

13. Safety Testing

13.1 Test the Close Cycle

- Press the OPEN button  or transmitter button to open the door (If the door starts closing, press the transmitter button to stop the door, then press transmitter again to open).
- Place a piece of timber approximately 40mm high on the floor directly under the door.
- Press the transmitter button to close door.
- The door should strike the object and re-open.
- Remove the timber .

WARNING! If the door is closing and is unable to re-open when obstructed, discontinue use Do not use a door with faulty obstruction sensing.

13.2 Testing the Open Cycle

- Press the CLOSE button  or transmitter button to close the door.
 - Press the transmitter button again to open the door.
 - When the door reaches approximately half way, firmly grab the door's bottom rail - the door should stop.
- If the door does not reverse readily when closing, or stop when opening, put the door into manual by pulling down on the manual release string to disengage the motor and contact 13 62 63 for support.

13.3 Test the Manual Door Operation

Periodically disengage the opener and manually operate the door. The door must be smooth to operate by hand. The force required on the bottom rail should not exceed 20kg.

CAUTION: Take care when completing a safety test. Failure to follow this warning can result in serious personal injury and/or property damage.

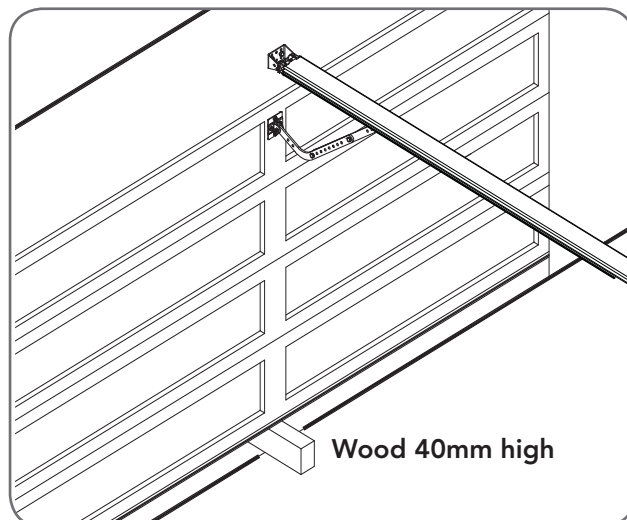

WARNING! If the door fails these tests, put the opener into manual mode, only operate the door by hand and call for service.





WARNING! Safety beams must be installed if the closing force at the bottom edge of the door exceeds 400N (40kg).

14. Auto-Close

Auto-Close mode is a function that automatically closes the door after a pre-set time. Safety beams must be installed in order to run the Auto-Close function. There are two types of Auto-Close available:

- i. Standard auto-close - the door will Auto-Close after a programmed time. In this mode the timer starts to countdown as soon as the door is fully open. This function is useful in case the safety beam does not get triggered.
- ii. Safety Beam triggered auto-close - the door will auto-close after a programmed time. In this mode the timer starts counting down only when the safety beam is triggered. ie car leaving the garage.

To enable the Auto-Close function:

- a. Press the MODE button repetitively until the GEAR  LED starts flashing.
- b. Press the OPEN button  until the GEAR  LED flashes:
 - i. two (2) times to get to PE auto-close or
 - ii. three (3) times to get to standard auto-close.
- c. Press STOP / SET button to enter parameter.
- d. The default setting for Auto-Close is OFF. Press the OPEN button  to move through options and the light's brightness will change accordingly.
- e. Press STOP / SET button to save the parameter's new value or press MODE to leave the value unchanged.

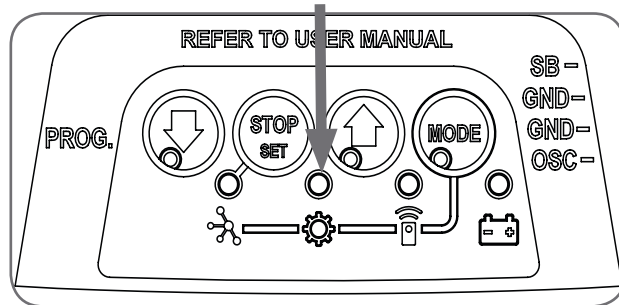

WARNING! It is compulsory to have Safety Beams installed when using Auto-Close mode.

Parameter		Value options = Indicated by brightness of main light (DEFAULT parameter underlined)					
Name	Flashes	1	2	3	4	5	6
PE AUTO-CLOSE	2	<u>OFF</u>	15sec	30sec	60sec	90sec	-
AUTO-CLOSE	3	<u>OFF</u>	15sec	30sec	60sec	90sec	120sec



15. Coding a Transmitter

15.1 Storing the Transmitter Code

The opener can only be operated from remote control transmitters that have been programmed into its memory. Up to 64 codes can be stored in the memory.

- Press the MODE button repetitively until the TRANSMIT  LED is lit.
- Press and HOLD the button/s indicated in the table to set the required transmitter function. The Main light will start to flash rapidly.
- Press one of the four (4) buttons on the transmitter until the main light starts to flash rapidly, then release transmitter button.
- Press the remote control button again until the main light stops flashing rapidly.
- Release both buttons. Press the MODE button to exit. The transmitter button is now coded, press to test.



NOTE: Refer to the Light indicator table for the details of the transmitter status.

MAIN LIGHT	TRANSMITTER STATUS
ON	Button added
OFF	Button removed
2 FLASHES, then OFF	Remote control deleted
4 FLASHES, then OFF	Memory full

15.2 Installation of the Wall Mounted Transmitter

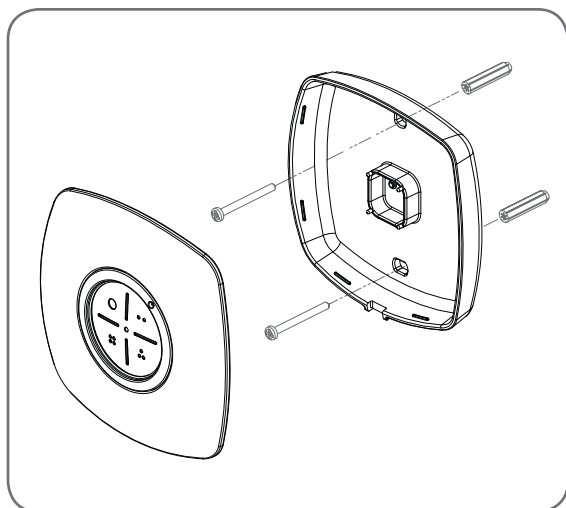
- Store the transmitter code as per instructions above. Test the transmitter button.
- Mount the transmitter in a convenient location, yet out of reach of children and at least 1.5m off the ground.
- Make sure the door is visible from this location.



TRANSMITTER FUNCTION	BUTTON		
			
Open / Stop / Close	HOLD		
PET (Pedestrian) Mode		HOLD	
Open			HOLD
Light	HOLD	HOLD	
Vacation Mode	HOLD		HOLD

* The button coded for open only function can close the door if you hold the button for 4 seconds, when the door is fully open..

15.3 Erasing All Transmitter Codes

- Press the MODE button repetitively until the TRANSMIT  LED is lit.
- Press and hold the MODE button for 10 secs, let the MODE button go when the main light stops flashing.
- Follow steps a - e in Storing the Transmitter Code to code new transmitters.

15.4 Vacation Mode

- To turn on Vacation mode and lock out all remotes, press the button on the remote programmed with Vacation Mode for 4 seconds.
- To turn off Vacation Mode, press the transmitter button programmed to vacation mode to turn off.

15.5 Remotely Coding Transmitters

Using this method transmitters can be coded without access to the opener's control panel as long as a pre-coded transmitter is available.

- Take any pre-coded transmitter. Press the button for the function to be duplicated and release.
- Using a small needle / pen, press and hold firmly for two seconds the middle button, through the Coding Hole.
- Within ten (10) seconds take the additional transmitter you wish to code. Hold the new transmitter's button for two seconds, pause for two seconds, hold again for two seconds and then release.
- Wait for ten (10) seconds and then press the new transmitter's button to test.

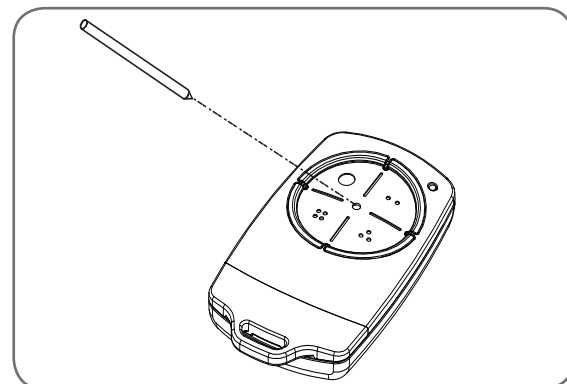

16. Smart Phone Control (SDO-7 only)



This device allows for operation of the door when not in line-of-sight of the door and opener.

The door may operate unexpectedly, therefore do not allow anything to stay in or near the path of the door. When the door is not operating automatically, watch the door when it is moving and keep people away until the door is completely opened or closed. **Contact with the moving door can cause serious personal injury or damage to property.**



It is our strong recommendation that your opener be fitted with **SAFETY BEAMS**. Safety Beams detect any obstructions in the door/gate's path and override automatic operation if one presents. These must be installed as in accordance with AS/NZS 60335-2-95:2012.





This is in addition to regular professional servicing, and monthly obstruction tests as detailed in Section 12.



tip Ensure limits are set prior to connecting to Wifi.

16.1 Connecting to Wifi

The Smart Phone Control works via your home's WiFi network. Initial set up involves linking your phone app, smart hub and opener to your home network.

- a. Download the B&D App.
- b. Ensure the WiFi router is within range of the opener.
- c. On the opener press the MODE button repetitively until the NETWORK  LED is lit.
- d. Press and hold the OPEN button on the opener for 4 seconds. The NETWORK  LED will turn purple when Hot Spot is Active.
- e. Go to phone settings, then WiFi and select (B&D000000).
- f. Open App and tap on Start.
- g. Select setup a new Smart Hub
- h. When Smart hub hotspot connection appears, select OK got it.
- i. Ensure WiFi network = (B&D000000) then select connect to hub.
- j. The opener main light and a red NETWORK  LED will start to flash.
- k. Press STOP / SET button on the opener.
- l. Name your smart hub on the app and select SAVE.
- m. Set the time zone and SAVE.
- n. Create an admin user and select "OK got it".
- o. Fill in name and password and select CREATE.
- p. Fill in email and security question or select skip this step and select SAVE.
- q. Select the push notification and select SAVE.
- r. Select and connect to WiFi. Choose your home WiFi and fill in password and select connect.
- s. The NETWORK  LED will change to solid blue.
- t. Now you can test the app.

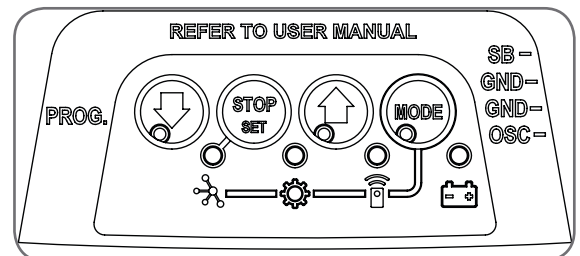

17. Home Owner Safety Warnings!

This automatic garage door opener is designed and tested to offer safe service provided it is installed and operated in strict accordance with the following safety warnings. Failure to comply with the following instructions may result in death, serious personal injury or property damage.

Please read these important safety warnings!



WARNING!

- When operating the manual release while the door is open, the door may fall rapidly due to weak or broken springs, or due to being improperly balanced.
- DO NOT disengage the opener to manual operation with children/persons or any objects including motor vehicles within the doorway.
- If the door is closing and does not re-open when obstructed, discontinue use. DO NOT use a door with faulty obstruction sensing.



ELECTROCUTION!

- Place opener in protected area so that it does not get wet.
- DO NOT spray with water .
- DO NOT open the protective covers.
- DO NOT operate opener if cable is damaged.



DO NOT DO IT YOURSELF

- Keep the garage door balanced. Sticking or binding doors must be repaired. Garage doors, door springs, brackets and their hardware are under extreme tension and can cause serious personal injury. DO NOT attempt any garage door adjustment. DO NOT use if repair or adjustment is needed. Call for a professional garage door service.



CAUTION:

Emergency access

- If your garage has no pedestrian entrance door, an emergency access device should be installed. This accessory allows manual operation of the garage door from outside in case of power failure.

Entrapment under operating door

- Watch the moving door and keep people away until the door is completely opened or closed. DO NOT operate door when persons are near the door.
- DO NOT allow children to play with door controls or transmitters.
- Regularly conduct Open and Close cycle testing.
- Ensure the garage door is in good working order by undertaking regular servicing.
- Wall transmitters should be installed in a location where the garage door is visible, but out of the reach of children at a height of at least 1.5m.
- Install Safety Beams (recommended).

Fall from Ladder

- Ensure ladder is the correct type for the job.
- Ensure ladder is on flat ground.
- Ensure user has 3 points of contact while on ladder.

Entanglement in or laceration from moving door

- Keep hands and loose clothing clear of door and guides at all times.
- Keep hands clear of moving door as sharp edges can cause cuts or lacerations.

18. Opener Safety & Security

18.1 Your Door CAN NOT be used by the opener when:

- There is a locking device installed.
- There is a power failure.

18.2 Your Door CAN be used when:

- There is an emergency, by disengaging the opener.
- There is a power failure, by disengaging the opener.

18.3 To Disengage the Opener:

- It is recommended to do so with the door in the closed position.
- Pull the manual release cord away from the door, until you hear a click.
- Move the door manually.

CAUTION: When the opener is manually disengaged, the door is no longer locked. To lock the door manually, re-engage the opener after the door is closed.

18.4 To Re-Engage the Opener:

- Check the door has not been locked by a locking device.
- Pull the manual release cord away from the door, until you hear a click.
- The door will now operate from the opener.

CAUTION: Do not use the string handle as a mechanism to open the door. Failure to comply may cause serious injury.

WARNING! When operating the manual release (while the door is open) the door may fall rapidly due to weak or broken springs, or due to being improperly balanced.
Do not disengage the opener to manual operation with children/ persons or any objects including motor vehicles within the doorway.

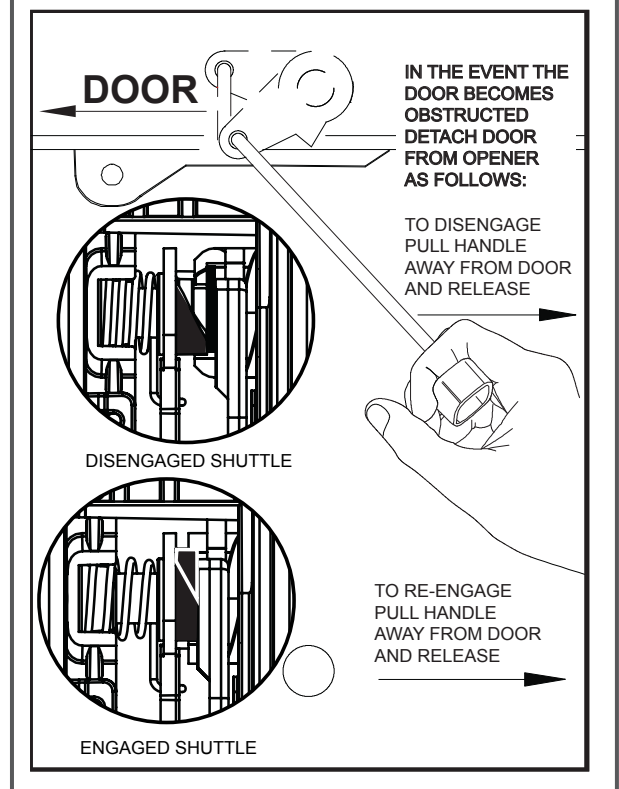

WARNING! Tracklock is NOT active when opener is disengaged from the track.

19. Operating your Opener

19.1 To Operate the opener:

- Press the programmed transmitter button until your door begins to move (usually 2 seconds). Make sure you can see the door when you use the transmitter.
- If you are in a vehicle you should aim the transmitter through your windscreen as shown.
- Check that the door is fully open or closed before you drive in or away.
- If you press the transmitter whilst the door is moving the door will stop. The next press of the transmitter will move the door in the opposite direction.

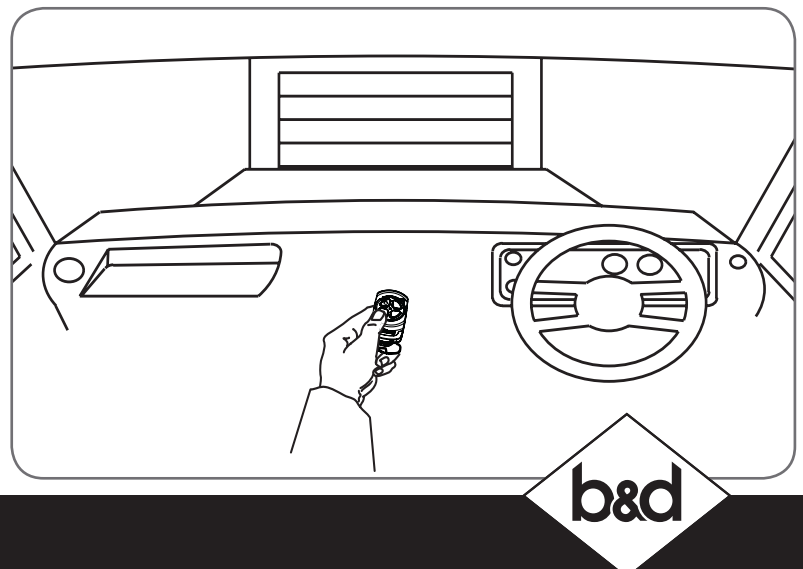

20. User Operating Controls

Button	Function
1. DOWN ARROW (Blue)	Closes the door
2. DOWN ARROW LED (Blue)	Illuminates when the door is closed and flashes when the door is obstructed on close or stopped.
3. STOP (Red)	Stops the door
4. UP ARROW (Green)	Opens the door
5. UP ARROW LED (Green)	Illuminates when the door is open and flashes when the door is open with the auto-close timer running, obstructed on opening or stopped.
6. MODE (Yellow)	Enables Load Diagnostics Mode
7. MODE STATUS LED (Yellow)	Illuminates when in Diagnostics Mode
8. BATTERY STATUS LED (Yellow) (SDO-7 only)	Illuminates when battery is charged and flashes when battery is charging, in use or battery failed.
9. REMOTE CONTROL STATUS LED (Red)	Flashes on remote lockout and flickers on remote control activity
10. ADJUSTMENT LED (Yellow)	Flashes a certain number of times depending on the parameter being changed.
11. NETWORK LED (SDO-7 Only) (Red, Blue, Purple)	Is a dual colour LED. Illuminates purple when hot spot active, blue when connected to cloud and red when in production mode. Flashes different colour depending on the activity.

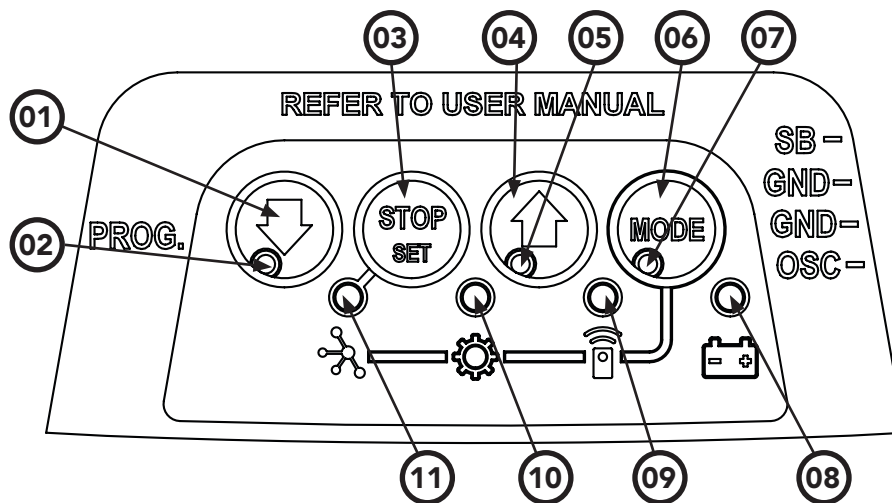

21. Maintenance

21.1 Door Maintenance

A poorly maintained door could cause fatal / serious injuries or damage to property.

- Frequently examine the door, particularly the cables, springs and mountings for signs of wear, damage or imbalance. **DO NOT USE** if repair or adjustment is needed since a fault in the installation or an incorrectly balanced door may cause injury.
- Fasteners: Check all screws, nuts and bolts to ensure they are secure.
- Spring Tension: It is natural for springs to lose tension. Should the door become hard to operate or completely inoperative, contact a door professional.
- Guide Tracks: Clean the internal sections of the guide tracks every 3 - 6 months with a cloth dampened with mineral turps or methylated spirits.

WARNING! Failure to maintain your garage door may void the warranty on your garage door opener.

DO NOT DO IT YOURSELF: Door adjustments should only be carried out by experienced persons, as this function can be dangerous if not performed under strict safety procedures.

tip Run the Safety Testing procedures MONTHLY in Section 13 to ensure garage door is fit for use.

21.2 Battery Replacement

Battery Type:

3V Lithium Battery CR2032.

- To test the battery is working, press and hold a transmitter button. Check Light Status table to determine if battery needs replacing

Light Status	Battery Status
Solid	OK
Flashing	Requires replacement
No light	Requires replacement

- Use finger nails to separate the transmitter casing to expose circuit board.
- Use a non-metallic object (e.g. pen) to remove the battery.

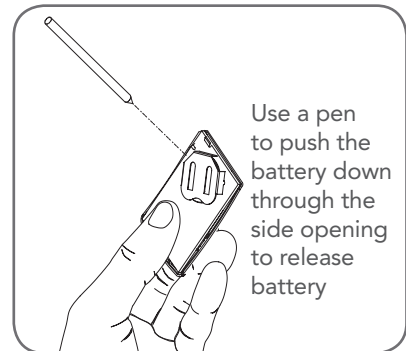

21.3 Battery Disposal

When batteries reach the end of their usual life in accordance with Australian Battery Recycling Initiative please follow the next simple steps for protecting the environment. Refer to the Automatic Technology website for information on where to recycle batteries in Australia.

DO NOT throw the batteries in municipal waste. This symbol of the crossed out wheeled bin indicates that the battery should not be placed in the municipal waste. Check your local regulations for appropriate disposal of the batteries.

Recycling all batteries will have other environmental and social benefits:

- Some batteries are less toxic but hazardous for other reasons. Lithium batteries can explode or catch fire in landfill, while button cells are dangerous if swallowed by children. Recycling offers a safe and environmentally responsible solution for end of life batteries.
- Battery recycling recovers non-renewable materials such as lead, cadmium, stella, zinc, manganese, cobalt, silver, plastics and rare earth elements.
- Removal of batteries and other hazardous household products from household waste facilitates the recovery of organic materials through alternative waste technologies such as composting. Batteries and heavy metals are known contaminants in compost.
- The community supports recycling because it reduces waste to landfill and achieves environmental benefits.

WARNING! Prior to disposal, recycling, or collection, all battery terminals must be securely insulated with a non conductive material to prevent any two batteries from short circuiting and generating heat during storage or transport. Battery terminals may be insulated with electrical tape; or batteries may be individually packaged in a non conductive material (e.g., plastic bag or original packaging).



22. Troubleshooting

Symptom	Possible cause	Remedy
The opener does not work from the transmitter	<p>Garage door in poor condition e.g. springs may be broken</p> <p>The opener does not have power</p> <p>The battery in the transmitter is flat</p> <p>The opener has turned on "Vacation Mode"</p> <p>The transmitter button is not programmed to operate the door.</p>	<p>Check the door's operation</p> <p>Plug a device of similar voltage (e.g. a hairdryer) into the power point and check that it is OK</p> <p>Replace the battery</p> <p>Turn off "Vacation Mode" (Section 14)</p> <p>Code in the transmitter</p>
One transmitter works but the other/s do not	<p>Faulty transmitter</p> <p>Flat battery</p>	<p>Replace transmitter</p> <p>Replace battery</p>
The chain / belt moves but the door remains stationary	The opener is disengaged	Re-engage the opener
Motor is running but chain / belt is not moving	Damage motor assembly	Contact your dealer for support.
The transmitter range varies or is restricted	<p>Variations are normal depending on conditions e.g. temperature or external interference</p> <p>The battery life is exhausted</p> <p>Position of the transmitter in the motor vehicle</p>	<p>Make sure you can see the door when you use the transmitter.</p> <p>Check the battery status by pressing a button (flashing or no light, battery need changing)</p> <p>Aim the transmitter through the windscreen.</p>
The Courtesy light does not work	LED has failed	Change LED.
The door reverses for no apparent reason	<p>This may occur occasionally from environmental conditions such as areas that are windy, dusty or have extreme temperature changes.</p> <p>If Safety beams are installed they may be partially obstructed.</p>	<p>Ensure the door runs smoothly before increasing the force pressure.</p> <p>Ensure the beam path is not obstructed. Check the Alignment.</p>
Door will not close	<p>Safety Beam not working</p> <p>Safety Beam battery flat</p>	<p>To access safety close mode, hold the transmitter button to close for 6 seconds and continue to hold while the door closes.</p> <p>Check Safety Beam</p>
Auto Close not working	Safety Beam or wiring faulty	Repair Safety Beam or replace wiring. Re-align optics. See Safety Beam instructions.
The door stops or moves very slowly under battery (Optional Battery Back Up Accessory)	The batteries may have little or no charge	Connect mains power and leave the batteries to charge. The batteries may take 24 hours to reach their maximum charge capacity.
The CLOSE (Blue) LED is flashing	Limits are not set	Set Up Limits (Section 11).

22. Troubleshooting

Main Light = Service / Warning Indicator:

Requirements for a service and user warnings are indicated after operation by the main light repeatable flashing OFF a number of times followed by a pause. The below table identifies the issues and remedies.

Flashes	Issue	Remedy
2	PE is preventing door from moving	Clear away any obstructions. Test Door. If unable to move the door and suspect beam is faulty, enter Safety Beam Emergency Close by pressing and holding a pre-coded button on transmitter for more than five seconds and the door will start closing.
3	Wireless LOCK battery is low	Change LOCK battery
4	Wireless PE battery is low	Change PE Battery
5	Wireless LOCK is not unlocked and preventing door moving	Check LOCK, test by pressing emergency release button on the lock and then test door operation.
6	Maintenance is due after pre-set number of cycles.	Contact dealer to arrange service.
7	Standby battery is faulty	Contact 1300 769 850 within Australia for assistance
8	Door was obstructed	Clear away any obstructions and test door opens/ closes correctly. (If door is damaged, contact your door professional)
9	Motor overloaded or stalled	Check the doors operation by disengaging the motor and ensuring the door runs smoothly. If necessary make door adjustments or contact your door professional.
10	Unit running on battery power (Only available with SDO-7)	Main light will flash (3) three times at the start of the cycle to indicate opener is running from battery backup and 10 flashes at the end of cycle. Check power supply.

Connecting or Disconnecting Accessories:

When disconnecting or reconnecting accessory base station modules (Wireless PE Beams or Autolock) press the MODE button repetitively until the GEAR LED is on, then press the STOP / SET button until the main courtesy light stops flashing.

If You Need a Service Call

If the opener needs a service please call the dealer who installed the garage door opener (their contact details are usually on a sticker on the back of your garage door). For product assistance contact 13 62 63 within Australia.

BEFORE CALLING you should have the following information to assist in providing the appropriate service:

1. Has anything happened since the opener last operated OK, e.g. a storm, a jolt to the door etc.?
2. What is the current light status on the opener?
3. Manually disengage the door (Section 17).
How easy is it to manually open and close the door?
4. What model is the opener? (Model no. information is located at the rear of the opener)
5. Who installed the opener? (Dealer details should be on a sticker on the back of your garage door)
6. When was it installed? (If known)







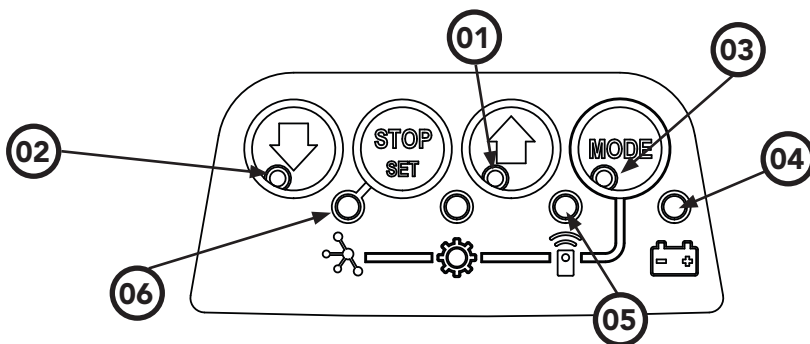

23. Appendix

A - Status Indication during Operating Mode.

LEDs	Light Status					Indicates
	BLUE	GREEN	YELLOW	RED	PURPLE	
DOOR OPEN (2) AND CLOSED (1) LEDS		solid				Open
			rapid flashing			Open with Autoclose timer running
			flashing			Opening / Obstructed on Open
	solid					Closed
	flashing					Closing / Obstructed on Close
	flashing	flashing				Stopped
	solid	solid			Partial Open	
MODE LED (3)			flashing			Load Diagnostics mode
BATTERY LED (4) (SDO-7 Only)			off			Battery not used / not fitted
			solid			Battery charged
			flashing			Battery charging, when connected to power, without power battery in use (holding STOP for 10s will shutdown)
			rapid flashing			Battery failed
REMOTE CONTROL STATUS LED (5)				flashing		Remote lockout
				rapid flashing		Remote Control Activity
NETWORK LED (6) (SDO-7 Only)					solid	Hot Spot Active
	1 flash then pause					Connecting to Wi-Fi
	2 flashes then pause					Connected to Server
	solid					Connected to Cloud
	rapid flashing					Interrupts Hub communications with opener
	alternate				flashing alternate	Requires confirmation from user Rebooting



B - Adjustment Mode Instructions





- Press the MODE button repetitively until the GEAR  LED starts flashing.
- Referring to the table below, select the desired parameter using the OPEN  and CLOSE  buttons and observing the number of flashes on the GEAR  LED. The selected parameter's value is indicated by the main light's brightness.
- Press STOP / SET button to start editing the parameter's value. The TRANSMIT  LED will turn on when editing is active.
- Use the OPEN  and CLOSE  buttons to step through the available options. The light's brightness will change accordingly.
- Press STOP / SET button to save the parameter's new value or press MODE to leave the value unchanged.
- Continue from a. above to select another parameter or press MODE to exit adjustment mode.

Parameter		Value options = Indicated by brightness of main light (DEFAULT parameter underlined)									
Name	Flashes	1	2	3	4	5	6	7	8	9	10
MARGIN	1	<u>0.7A</u>	0.9A	1.2A	1.5A	2.0A	-	-	-	-	-
PE AUTO-CLOSE	2	<u>OFF</u>	15sec	30sec	60sec	90sec	-	-	-	-	-
AUTO-CLOSE	3	<u>OFF</u>	15sec	30sec	60sec	90sec	120sec	-	-	-	-
LIGHT TIMER	4	30sec	60sec	90sec	120sec	<u>180sec</u>	240sec	-	-	-	-

C - Adjusting Force Margins

The Safety Obstruction Force is calculated automatically during setup. Adjusting this is normally only necessitated by environmental conditions such as windy or dusty areas, and areas with extreme temperature changes.

To Increase / Decrease Force Pressure

- Press the MODE button repetitively until the GEAR  LED is flashing.
- The LED will start flashing with one flash every second.
- Press the STOP / SET button and the MODE button LED and the TRANSMIT  LED will be lit and the GEAR  LED will flash once every second.
- By pressing the OPEN button  will increase the force pressure and CLOSE button  will decrease the force - Main light will dim or brighten as the pressure is decreased or increased.
- Press STOP / SET button to save the new value. (Refer to Appendix B for margin settings)
- Test the force again as per Testing Close Cycle and Testing Open Cycle.

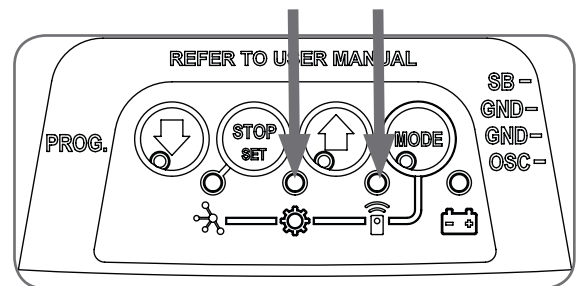



D - Battery Functions

- Holding the STOP button for 10secs when running from battery backup will shut the PCB down so as to reduce battery current consumption to a minimum.
- Holding the STOP button for 4secs when a battery is fitted and running from mains power will cause the controller to test the battery state to determine if it is disconnected / open circuit, missing, faulty or ready.



E - Setting Limits via Transmitter

- a. Switch power on and the BLUE LED on the CLOSE button  will start to flash to indicate that the opener is ready to set the Close travel limit
- b. Press the MODE button until the TRANSMIT  LED is lit.
- c. Press and HOLD the CLOSE button  to set the Open / Stop / Close function. The Main light will start to flash rapidly.
- d. Press and hold button 1 on the transmitter, then release transmitter button.
- e. Press and hold button 1 on the remote control button again until the main light stops flashing rapidly.
- f. Release both buttons. The transmitter button is now coded, press to test and observe the speed of the door through a full cycle.
- g. The drive speed is set to the fastest setting by default. This may not be suitable for larger doors or for single piece doors:

CLOSE limit:

- i. Using the programmed transmitter, press and hold the button 4 to close. To inch the door, single presses of the button 4 will move the door to desired limit.
- ii. While inching (to CLOSE) to set the close speed, press and hold button 4 on the remote and by pressing the SET button 2 the opener will cycle through all three speed modes as shown in table.
- iii. Once at the desired speed, release the remote button 4.
- iv. Continue inching the door to the desired position. We recommend the CLOSE limit position being the first point of contact of the rubber strip (at the bottom of the door) with the ground.
- v. If the door overshoots, press the OPEN button 1 on the remote to move the door in the OPEN direction.
- vi. When the door is at the desired CLOSE position, press the SET button 2, the GREEN LED on the OPEN button  will now flash.

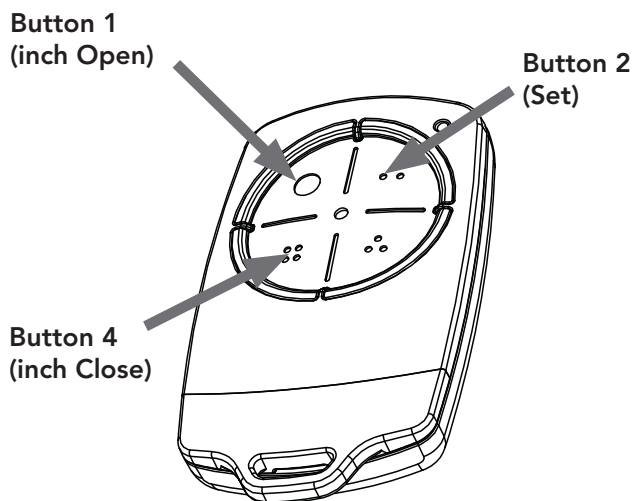

OPEN limit:

- i. Using the programmed transmitter, press and hold the button 1 to open. To inch the door, single presses of the button 1 will move the door to desired limit.
- ii. While inching (to OPEN) to set the open speed, press and hold button 1 on the remote and by pressing the SET button 2 the opener will cycle through all three speed modes as shown in table.
- iii. Once at the desired speed, release the remote button 1.
- iv. Continue inching the door to the desired position. We recommend the OPEN limit position being the height of the garage opening
- v. If the door overshoots, press the CLOSE button 4 on the remote to move the door in the CLOSE direction.





WARNING! The door will automatically close, open and close again after the next step. Ensure that nothing is in the door's path.

- vi. When the door is at the desired OPEN position, press the SET button 2. The door will now automatically close and open to calculate the safety obstruction settings.

F - Setting the PET mode position

When activated, PET mode drives the door to a preset position from the close position, therefore allowing a pet or parcel to go under the door.

- a. Drive and stop the door at the desired PET mode open position by pressing the transmitter button coded for Open/Stop/Close operation.
- b. Press the MODE button until the GEAR  LED is lit.
- c. Press OPEN button  to save PET position - Main light will flash and both OPEN and CLOSE LED will light up.

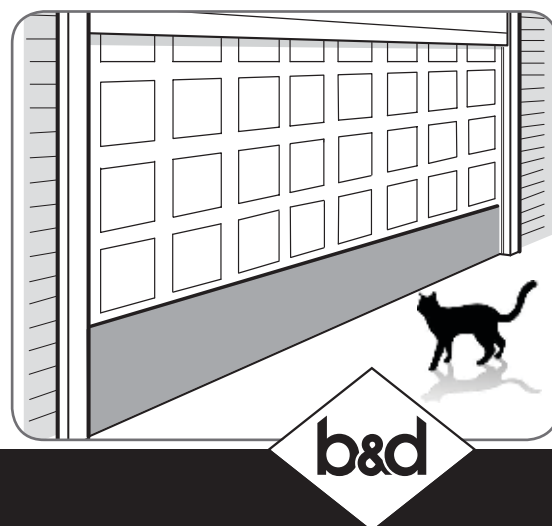

G - Setting up Tilt Door

Prior to limit set up, the opener can be set to J-Type Tilt Profile. This process allows the opener to pre-set to J-Type settings where the limit is not greater than 1500mm. If J-Type is selected, the speed is customised and cannot be changed.

- a. Press the MODE button repetitively until the GEAR  LED starts flashing.
- b. Press and hold STOP / SET button for 2 seconds to check the door type, until the main courtesy light turns solid ON or OFF.
 - Main courtesy light ON - Tilt type (J-Type only)
 - Main courtesy light OFF - Sectional type
- c. Press and hold STOP / SET for 6 seconds to change the door type, until the main courtesy light turns solid ON or OFF. If required, repeat step b to check the door type selected.
- d. Press MODE button to exit the door selection mode. Proceed to Section 12 to set the limits.

24. Warranty

This Warranty is given by B&D Doors a division of B&D Australia Pty Ltd (ABN 25 010 473 971), 34-36 Marigold St, Revesby 2212, 13 62 63, enquires@bnd.com.au.

PLEASE NOTE:

- This Warranty is in addition to any statutory, non-excludable guarantees or warranty rights and remedies under the law. See section 5 below.
- This warranty applies to the original purchaser only and may not be transferred.
- This Warranty is to be read in conjunction with the owner's copy of the installation instruction manual.
- In this warranty, 'B&D Representative' means an entity authorized by B&D to service B&D products. Please check the B&D website for details.



It is a condition of the below warranties that the manual operating (opening and closing) force of the door by hand does not exceed 20kg.

MODEL	WARRANTY	DOOR (MAX)
SECTIONAL		
CAD Smart	7 yrs / 20,000 cycles	236kg
CAD Secure	7 yrs / 20,000 cycles	236kg
CAD Advance	7 yrs / 20,000 cycles	200kg
CAD S	7 yrs / 20,000 cycles	175kg
Panel Pro	5 yrs / 10,000 cycles	110kg
ROLLING		
CAD PowerDrive	7 yrs / 20,000 cycles	110kg
Roll-A-Pro	5 yrs / 10,000 cycles	110kg
EXTRAS		
TRACK ASSEMBLY (includes all parts)	1 year	
TRANSMITTERS & ACCESSORIES	1 year	

NOTE: CONSUMABLES (eg Batteries in remote control transmitters and light bulbs and fuses) are not covered by this warranty

1. MAKING A CLAIM

- (a) The product parts in the above table should operate in accordance with the product manual for the time period shown or for the number of cycles, whichever occurs first; provided you comply with the manufacturer's instructions concerning installation, operation, maintenance and testing. Failure to do so may void all or part of this warranty.
- (b) If, during the relevant warranty period, a product part in the table above appears to contain a defect, call the retailer from whom you purchased the product, or B&D on 13 62 63, and they will instruct you what to do next.
- (c) You are responsible for the cost of making a claim under this Warranty. Additional access expenses where the Product is not readily accessible must be borne by you.
- (d) If B&D or B&D's Representative confirms the product is defective and covered by this Warranty, B&D will repair or replace it (at B&D's sole option) at no cost to you. Goods presented for repair may be replaced or repaired by refurbished goods or parts of the same type.

2. WARRANTY CONDITIONS

It is a condition of this warranty that:

- (a) you provide a copy of the receipt of original purchase of the product, and the serial number of the Product which can be found on the label adhered to the Product.

- (b) the door and opener are properly maintained by being serviced by a qualified professional at regular, appropriate intervals. What is appropriate may vary based on environmental factors (eg. weather, salt exposure) and level of usage. Based on average use and environmental conditions, B&D recommends that the product is serviced by B&D or a B&D Representative, within 12 months of installation (to allow for new doors to settle) and at regular intervals not exceeding 2 years.

3. WARRANTY EXCLUSIONS

- This warranty excludes defects or improper operation resulting from:
- (a) excessive wear and tear that may cause the product to fail;
 - (b) accidental, deliberate or negligent damage or damage caused by insects, dirt, plants or other objects;
 - (c) blown fuses, electrical surges, power surges or power spikes or faulty or unsuitable electrical wiring of structures to which the product is affixed;
 - (d) theft, fire, flood, rain, water, lightning, storms or any other acts of God;
 - (e) salt or other corrosion due to environmental conditions;
 - (f) any installation, configuration or use of the product contrary to the instructions supplied with the product;
 - (g) maximum continuous operating time exceeding 1 minute in 10 minutes;
 - (h) the manual operating (opening and closing) force of the door by hand exceeding 20kg;
 - (i) weight exceeding amounts listed in table above;
 - (j) the door used with the product not being in safe working order and condition;
 - (k) any modification to the product or acts of any person in respect of the product which are not authorized by B&D and which impact Product performance;
 - (l) installation of a residential garage door opener in a commercial or industrial premises or in a dwelling other than a single-family dwelling; or
 - (m) radio or electrical interference or lack of availability of signal.

4. OTHER CONDITIONS

- (a) This Warranty is not transferable.
- (b) The warranty period stated in the table will not be extended for Products or parts repaired or replaced during the relevant warranty period.
- (c) Where the Product is sold by any person other than B&D, except for the warranty set out above, such person has no authority from B&D to give any warranty or guarantee on B&D's behalf in addition to the warranty set out above.

5. STATUTORY GUARANTEES OR WARRANTIES IN AUSTRALIA

If you are a consumer under the Australian Consumer Law, our goods come with guarantees that cannot be excluded under the Australian Consumer Law. You are entitled to a replacement or refund for a major failure and for compensation for any other reasonably foreseeable loss or damage. You are also entitled to have the goods repaired or replaced if the goods fail to be of acceptable quality and the failure does not amount to a major failure. This warranty certificate and other statements contained in this document or other B&D documents given to you do not exclude, restrict or modify the application of all or any of the provisions of the Australian Consumer Law.

To the extent permitted by the Act or other laws, B&D:

- (a) limits its liability for breach of a statutory guarantee to the payment of the cost of replacing the Product or acquiring an equivalent Product; and
- (b) expressly excludes any liability for consequential loss and incidental or indirect damages (including but not limited to damages for loss of business profits, income, business, goodwill or reputation, or business interruption) due to a defect of the Product.

b&d group office locations

Head Office	6-8 Fiveways Blvd, Keysborough 3173	Phone (03) 9791 0200
New South Wales	34 Marigold St, Revesby 2212	Phone (02) 9722 5555
Queensland	17 Oasis Court, Clontarf 4019	Phone (07) 3883 0200
Victoria	147-153 Canterbury Rd, Kilsyth 3137	Phone (03) 9237 7766
South Australia	23 Frederick Rd, Royal Park 5014	Phone (08) 8440 4747
Western Australia	96 Mulgool Rd, Malaga 6090	Phone (08) 9247 8777
International/Export	34 Marigold St, Revesby 2212	Phone +61 (0)2 9722 5555

your representative is

Prefix trademarks are the property of B&D Australia Pty Ltd. B&D Doors & Openers is a division of B&D Australia Pty Ltd. ABN 25 010 473 971. © 2016 B&D Australia Pty Ltd.

www.bnd.com.au

